

Tendo em conta a simetria do problema, apresentam-se os resultados apenas para o quarto da laje assinalado.

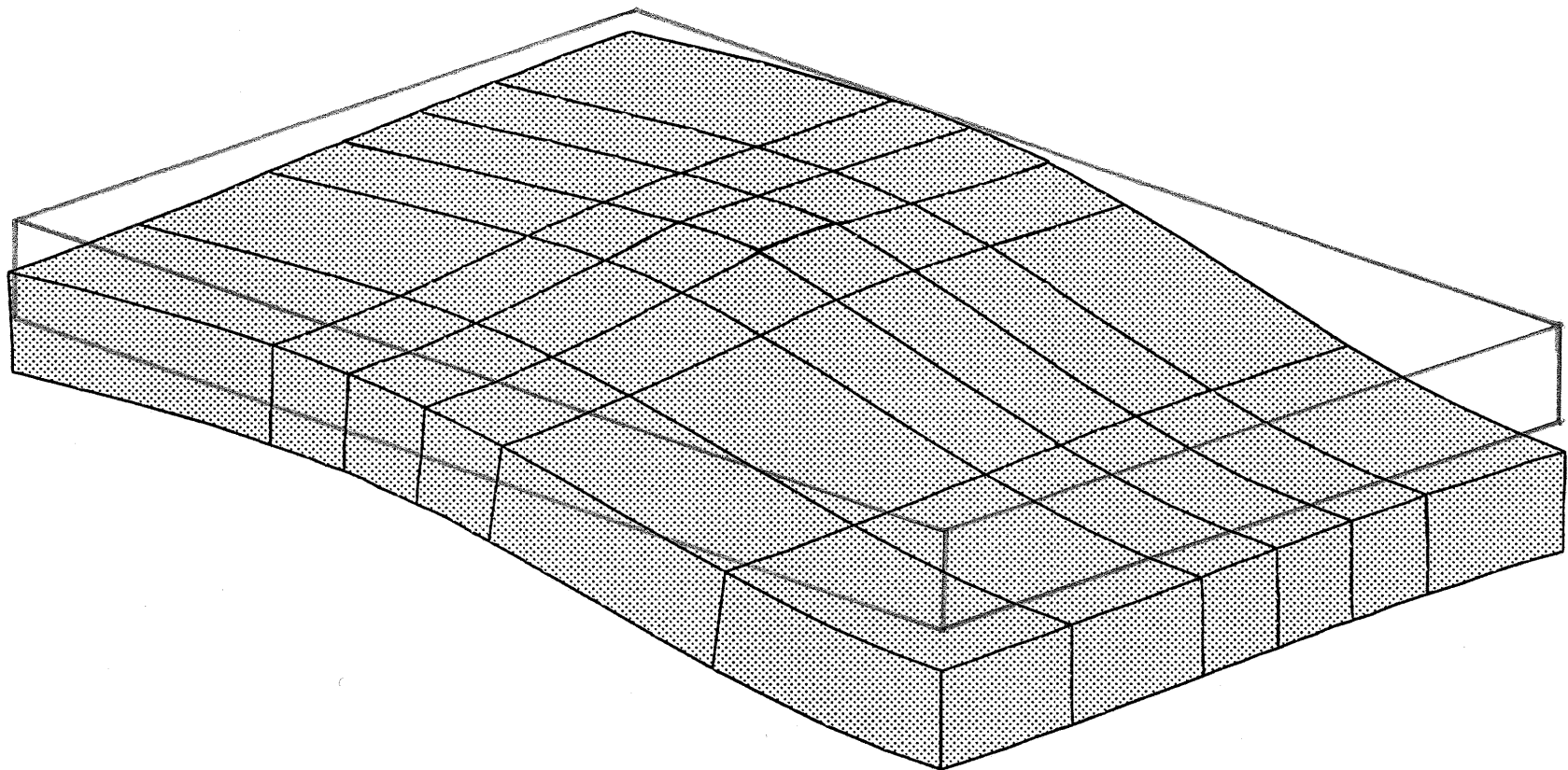

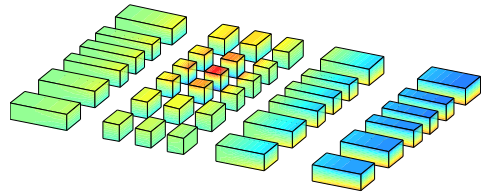

$\sigma_{xx}$

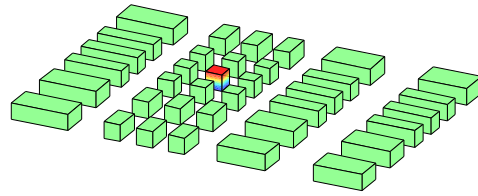

$\sigma_{zz}$

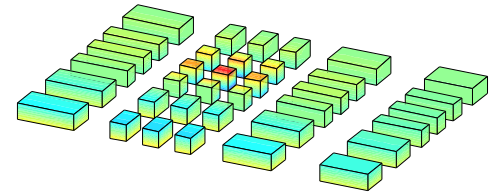

$\sigma_{yy}$

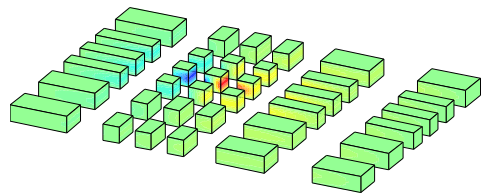

$\sigma_{xz}$

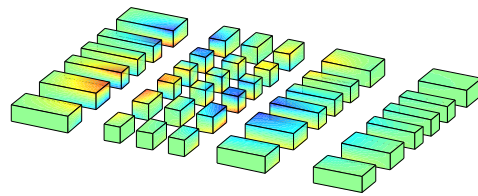

$\sigma_{xy}$

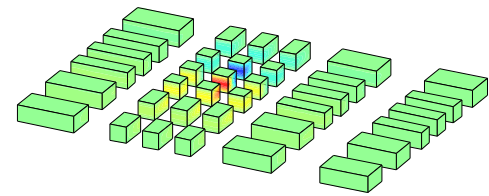

$\sigma_{yz}$

