



## **Evaluation of a novel type of reactor for the realization of continuous enzymatic hydrolysis of lignocellulosic materials**

**Catalina María Gaona Freire**

Thesis to obtain the Master of Science Degree in

**Energy Engineering and Management**

Supervisors: Prof. Ana Paula Vieira Soares Pereira Días

Dr. Judith Buchmaier

**Examination Committee**

Chairperson: Prof. Francisco Manuel Da Silva Lemos

Supervisor: Prof. Ana Paula Vieira Soares Pereira Dias

Member of the Committee: Prof. José Augusto Dâmaso Condeço

**December 2019**



## **InnoEnergy MSc SELECT- Environomical Pathways for Sustainable Energy Systems**

Master Thesis in partnership with:

**AEE INTEC**

Special thanks to the industrial supervisors:

**Judith Buchmaier**

## Abstract

Nowadays there is a high consumption of plastics, fossil fuels and a wide range of chemicals, which generate a variety of impacts on the environment. There is a need to provide more sustainable pathways to generate products that can replace the fossil fuel-based industry. Biorefineries have a high potential to provide a variety of products from lignocellulosic materials. Residues of forestry and agriculture are available in great quantity and can be processed to obtain a wide range of products, such as biofuels, bioplastics and biochemicals. In this context, the project 'OSCYME' was launched in 2017 to test a new type of reactor, the Oscillatory Flow Bioreactor (OFB). The aim of this work was to continue previous work, this time testing the reactor in continuous mode to assess the enzymatic hydrolysis of pure  $\alpha$ -cellulose. Tests were conducted in OFB batch mode and OFB continuous mode and compared to results of hydrolysis obtained in a stirred tank reactor (STR). The results show a great potential for the OFB continuous mode, yielding 14% more glucose equivalent than STR even when considering the maximum error. Compared to the STR, the OFB presents improvements in vessel size, solid loading processing and energy consumption, all leading to a reduction of costs. Nevertheless, a number of challenges remain, and further studies need to be conducted to better understand the mixing capacities and enzyme-substrate binding in the OFB.

Keywords: Lignocellulosic materials, enzymatic hydrolysis, oscillatory baffled reactor, cellulose, glucose production.

## Resumo

Hoje existe um elevado consumo de plásticos, combustíveis fósseis e uma vasta gama de produtos químicos, que geram graves impactos no ambiente. É necessário criar vias sustentáveis de produção para substituir a atual dependência de combustíveis fósseis. As biorefinarias têm um elevado potencial para fornecer uma variedade de produtos a partir de materiais lignocelulósicos. Os resíduos da silvicultura e da agricultura estão disponíveis em grande quantidade e podem ser processados para obter uma vasta gama de produtos, como biocombustíveis, bioplásticos e bioquímicos, como é caso o projeto "OSCYME", lançado em 2017 para testar um novo tipo de reator: o biorreator de fluxo oscilatório. Este trabalho visa a continuação do projeto anterior, testando o reator em modo contínuo, avaliando hidrólise enzimática da celulose pura  $\alpha$ . Os testes foram realizados em modo batch OFB e modo contínuo OFB e comparados com resultados de hidrólise obtidos num reator de tanque agitado (STR). Os resultados mostram um grande potencial para o modo contínuo OFB, produzindo 14% mais glucose equivalente a STR mesmo quando se considera o erro máximo. Em comparação com o STR, o OFB apresenta melhorias no tamanho do vaso, no processamento da carga sólida e no consumo de energia, o que leva a uma redução de custos. No entanto, persistem vários desafios e é necessário realizar mais estudos para compreender melhor as capacidades de mistura e da ligação enzima-substrato no OFB.

Palavras-chave: Materiais lignocelulósicos, hidrólise enzimática, reator oscilatório desconcertado, celulose, produção de glicose

# Contents

Abstract.....	I
Resumo .....	II
Tables index .....	IV
Figures index .....	V
1. Introduction .....	1
2. Fundamentals.....	3
2.1 Lignocellulosic biomass .....	3
2.1.1. Lignocellulose potential .....	3
2.1.2 Structure of lignocellulosic material.....	4
2.1.3 Enzymatic conversion.....	6
2.2. Reactors for the processing of lignocellulosic materials .....	10
2.2.1 Batch and continuous operation of enzymatic processes.....	10
2.2.2 Oscillatory flow bioreactor .....	10
2.2.3 Intensification Potential .....	14
3. Experimental .....	15
3.1 Oscillatory flow bioreactor .....	15
3.1.1 Oscillatory pump .....	17
3.1.2. Modular design.....	19
3.2 Materials.....	21
3.2.1 Laboratory equipment.....	21
3.2.2 Chemicals .....	22
3.2.3 Other materials .....	22
3.3 Methodology .....	23
3.3.1 Experimental Procedure.....	23
3.3.2 Experimental Plan.....	24
3.3.3 Sampling procedure .....	25
3.3.4 Sampling Analysis and Calibration.....	25

3.3.5 Parametric tests .....	28
3.3.6 Hydrolysis tests.....	29
4 Results and Discussion .....	30
4.1 Batch experiments.....	30
4.1.1 Total solids.....	30
4.1.2 Hydrolysis .....	31
4.2 Continuous mode experiments .....	37
4.2.1 Evaluation of Flow Patterns.....	37
4.2.2 Power measurements .....	38
4.2.3 Total solids.....	40
4.2.4 Hydrolysis .....	41
5. Process application .....	44
6. Challenges and future work .....	46
REFERENCES .....	50

## Tables index

Table 1. Applicable oscillatory frequencies correlated to the adjustable engine power numbers. ....	18
Table 2. Laboratory equipment.....	21
Table 3. Chemicals. ....	22
Table 4. Other materials. ....	22
Table 5. Experimental plan for both continuous and batch configurations. ....	24
Table 6. DMA and DNS glucose measurements for 24-hour batch experiment and results variations.....	27
Table 7. Experiments in continuous mode and batch mode to test energy, total solids and residence time. ....	28
Table 8. $\alpha$ -cellulose batches and their respective particle composition.....	33
Table 9. Flow measurements in continuous mode at different parameter configurations. ....	37
Table 10. Calculated and measured residence time with ink experiments. ....	37
Table 11. Solid loadings at different ports and times in the hydrolysis of 11% cellulose in continuous mode. ....	40
Table 12. Comparison of STR vs OFB continuous system. ....	45

## Figures index

Figure 1. Overview of an integrated biorefinery working with lignocellulosic materials to produce fuel, chemicals and energy [9].	3
Figure 2. Cellulose in plants, protected by hemicelluloses and lignin [19].	5
Figure 3. Main reactions and inhibitions during enzymatic hydrolysis. Main reactions (1, 2), glucose inhibition (3, 4), cellobiose inhibition (5), substrate inhibition (6, 7). [30].	8
Figure 4. Stirred tank reactor, diagram by Daniele Pugliese.	10
Figure 5. Baffle types. A. Single orifice, B. Multi-orifice and C. Helical baffle.	11
Figure 6. Oscillatory flow bioreactor jacketed module.	11
Figure 7. Different types of flow and their explanatory illustration by [35].	12
Figure 8. Upward and downward stroke scheme [5].	13
Figure 9. Laboratory plant scheme of the OFB.	15
Figure 10. OFB pilot plant with one module connected.	16
Figure 11. Laboratory scheme of the OFB plant.	17
Figure 12. Modular parts, some partly insulated.	19
Figure 13. OFB batch configuration.	20
Figure 14. OFB continuous mode configuration as seen from the left side and the right side.	21
Figure 15. Calibration of different buffers prepared in the labelled dates, with the linear equation for the 12 <sup>th</sup> of August as an example.	26
Figure 16. Total solids distribution in OFB batch mode.	30
Figure 17. Mean glucose equivalent concentration for pre-addition of enzyme in OFB batch mode.	31
Figure 18. Mean glucose equivalent concentration for inline addition of enzyme in OFB batch mode.	32
Figure 19. 24-hour hydrolysis of 11% solid loading in OFB batch configuration.	32
Figure 20. OFB Batch vs STR hydrolysis experiments with Original cellulose.	34
Figure 21. OFB batch hydrolysis with two different types of cellulose.	35
Figure 22. OFB batch with Partner cellulose vs STR with Original cellulose hydrolysis.	35
Figure 23. OFB batch vs STR hydrolysis experiments with Arbocel.	36
Figure 24. Power consumption at different net flow pump and oscillatory pump configurations for the continuous mode system filled with water.	38
Figure 25. Power consumption of the oscillatory pump with water and 12% solid loading.	39
Figure 26. Total solids distribution in 3 ports of the OFB continuous mode configuration, at a 11% solid loading.	40
Figure 27. Graphs from the experiment series Conti 24 showing the temperature inside the reactor and the glucose yield along the time.	42
Figure 28. Degree of hydrolysis for the cellulose in OFB-Batch, OFB- Continuous mode and STR.	43

# 1.Introduction

Nowadays, most of the plastic, fuels as well as a wide range of chemicals that we consume are produced mainly from fossil fuels and petrochemical industry. These products are consumed vastly around the world, leading to major environmental issues such as greenhouse gas emissions, plastic pollution in the oceans, ocean acidification, among many others. In addition to the environmental impacts, the demand for transportation fuels, chemicals and plastic for packaging will continue (and increase), which constitutes yet another problem considering that the sources of fossil fuels are finite [1,2].

Due to the aforementioned problems, there is a need to boost biorefineries in order to provide more sustainable solutions to fulfil the need and demand of transportation fuels, chemicals and plastics [1]. Using renewable sources and even what is regarded as waste from different industries, such as forestry and agricultural industries, is a necessary step to take towards a more sustainable world. The bioprocessing of biomass will play a crucial role since a variety of chemical compounds can be obtained, which can be further processed to produce a wide range of products.

There is a high interest on the biorefining of lignocellulosic materials, which are composed of cellulose, hemicelluloses and lignin [3]. These materials are the only foreseeable resource for sustainable carbon to support the rapidly rising demand for energy and chemicals [4]. They are available in abundance [1] and currently a large amount is discarded as waste, which could be given a second life. Among the products that can be derived from the processing of lignocellulosic materials, liquid biofuels, are the most heard of since they are currently the most sustainable source of energy to fulfil the demand from the transport sector, this includes aviation and heavy-duty vehicles. Bioplastics and biochemicals are also an appealing option to replace the current available products. The alcohols that are obtained from the lignocellulosic material, through fermentative pathways of microorganisms, can be utilized as liquid fuels. However, the quality and characteristics of the alcohols need to fulfil a diverse list of qualifications in order to be adequate for its use as fuel. There are several challenges yet to be overcome to make this process of biofuel obtention attractive and competitive for commercialization. Nevertheless, there is interest in this area and ongoing research to make this type of industry more feasible.

In this context, the project "OSCYME" was launched in 2017 initiated by the Institute for Sustainable Technologies (AEE INTEC) in partnership with the University of Newcastle, Austrian Centre of Industrial Biotechnology and Möstl Anlagenbau GmbH. The full title of the project is "Oscillatory enhancement of enzymatic hydrolysis as milestone for value added processing of ligno-cellulosic residues". In this project, a new type of reactor was developed with the intention to optimize the formation of fermentable sugar from enzymatic hydrolysis of ligno-cellulosic waste material. The designed bioreactor potentially decreases the energy demand and the amount of enzyme required, while at the same time increasing the yields of obtained sugar, resulting in a reduction of costs. In the previous thesis



work conducted [5], the scalable laboratory pilot plant "Oscillatory Flow Bioreactor" (OFB) has been tested in batch mode and the optimal parameters have been identified.

This master thesis is developed with the objective to continue the former work and test the OFB in a different set-up, this time as a semi-continuous process, incorporating new elements to the system, such as a net flow pump. Additionally, batch experiments were conducted testing different methods for sampling and feeding of the materials into the system. An appropriate continuous mode layout was implemented, and hydrolysis tests were performed, measuring energy requirements, glucose yield and comparing with previously obtained results in batch layout and stirred tank reactor tests.

## 2. Fundamentals

### 2.1 Lignocellulosic biomass

#### 2.1.1. Lignocellulose potential

Among the definitions of biomass, the following is found ‘any form of organic matter that can be found on earth, with one property that is common for all of its forms; it is or had to be a living organism in one point of its existence’ [6]. Biomass has been used for thousands of years as a source for energy, heat and light. But in the last decades there has been an urgent need to develop more sustainable energy systems and industries based on renewable biomass, such as lignocellulosic biomass, due to the increase in demand for energy and the rapid depletion of fossil fuels [7].

Lignocellulosic biomass is the most abundant and bio-renewable biomass on earth and numerous studies have shown that it has great potential for the sustainable production of chemicals and fuels [1]. A wide range of products can be produced from lignocellulosic materials, without the need of adding fossil fuel-based products [8] and it is expected that biorefineries will gradually replace the present petro-chemical industry [9]. A biorefinery can use lignocellulosic materials producing energy, chemicals and fuels at the same time, as seen in figure 1.

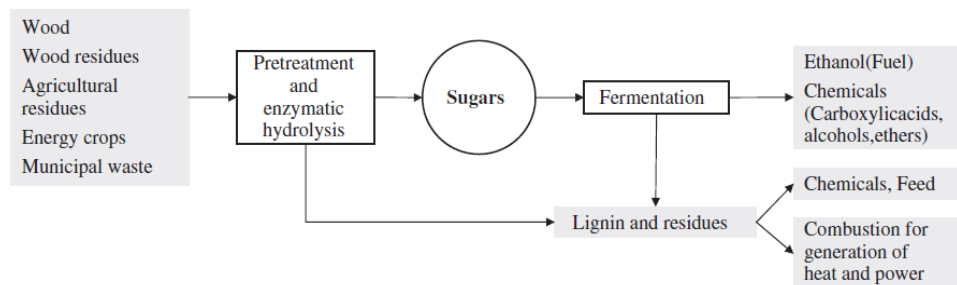

Figure 1. Overview of an integrated biorefinery working with lignocellulosic materials to produce fuel, chemicals and energy [9].

One of the advantages of producing fuels with this kind of materials, is that unlike current methods, such as producing bioethanol from sugar cane crops, lignocellulosic biomass does not generate problems related to food competition of certain crops, since it uses the non-edible part of the crops and plants. Additionally, the large amounts of waste generated from forestry, agriculture and agro-industry has the potential to be used in the lignocellulosic materials biorefinery, giving an added value to said sectors [10]. It is possible to obtain lignocellulosic biomass at a low price, making that a big advantage against crude oil and even against crops that are grown as feedstock to produce biofuels.

Fuels produced from lignocellulosic materials are second generation fuels. There are four steps needed in order to convert the lignocellulosic materials into fuels; pre-treatment, hydrolysis to sugars, fermentation and product/coproduct recovery [11]. Currently, the obtention of products such as biofuels and bioplastics from lignocellulosic biomass faces some obstacles. Compared to the hydrolysis of starch, the capital requirement for cellulose hydrolysis is higher mainly due to the reactor capacity requirement per unit sugar output, which is due to the slow reaction and therefore longer hydrolysis times needed for lignocellulosic biomass [12].

The development of biotechnological processes to prepare the lignocellulosic material and decompose it into its fundamental structures at a low cost is the first step, known as pre-treatment [13]. With pre-treatments, the access of enzymatic or chemical action to the cellulose and hemicellulose is increased. These processes need to be cost-effective, simple, environmentally friendly, energetically efficient and should be able to work for a wide range of feedstocks [14]. The hydrolysis, where sugars are obtained from lignocellulose, is a key step and the challenge is to make it more efficient and cost-effective [9]

The process for obtention of glucose monomers from cellulose via hydrolysis is called saccharification. The obtained glucose can be further processed to obtain different chemicals such as ethanol and butanol [15]. The high prices associated to the processing are one of the main drawbacks [8]. It has also been found that after capital and feedstock costs, when cellulosic materials are used to produce ethanol, enzymes are the third component with the largest associated cost [12]. This makes, as an example, the price per gallon for bioethanol from lignocellulosic material not competitive in today's market.

Compared to crude oil, lignocellulosic biomass has higher amounts of oxygen and lower fractions of both hydrogen and carbon [1]. It is because of this characteristic that a wider range of products can be obtained, but in order to acquire them a variety of processing technologies needs to be developed and implemented, which results in an impact in the cost of the products.

It is common that the lignin and hemicelluloses fractions of the material are discarded as waste, but to make the lignocellulosic biorefineries thrive, processes that use lignin and hemicelluloses to generate high-value products have to be developed in parallel with the optimal use of cellulose in hydrolysis. Components from the lignocellulosic biomass should be properly separated and given a use to take full advantage of the raw material [16]. In general, a number of steps need to be improved in order to make the lignocellulosic biorefinery more attractive commercially.

If the previously mentioned problems are tackled, lignocellulosic materials can become the raw material of choice for the development of sustainable biological and chemical industries. The biorefining of these materials are of interest since it has the potential to contribute to climate change mitigation, rural economic development and improve the sustainability of agricultural landscapes and activities [17].

### 2.1.2 Structure of lignocellulosic material

Lignocellulosic biomasses are composed in the greatest part by cellulose (35 – 50%), hemicellulose (20 – 35%), lignin (10-25%) and other components such as pectin, ashes, lipids and protein in smaller amounts [1]. Cellulose, hemicellulose and lignin are highly organized forming complex matrices [18]. The ratio of the components varies in different plants and crops. Cellulose is the most abundant natural polysaccharide on Earth, being part of the components in all land plants, present in the cell walls of them, as seen in figure 2.

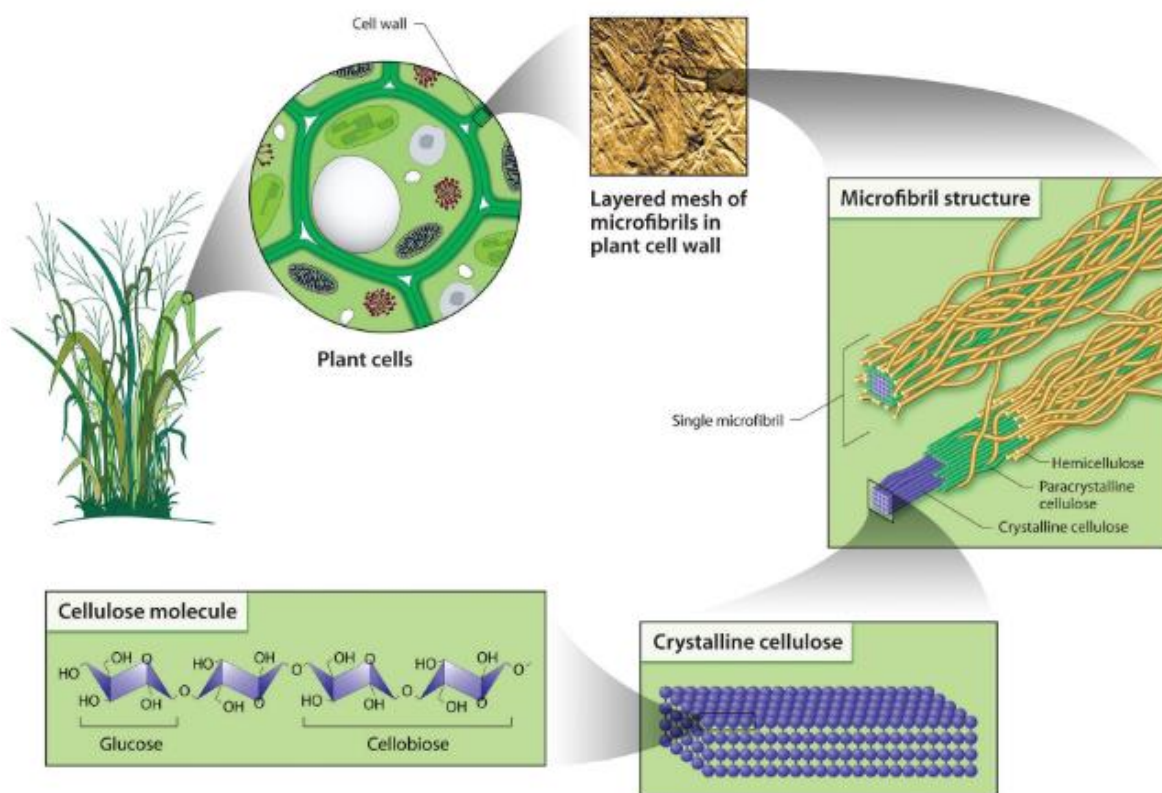

Figure 2. Cellulose in plants [19].

Cellulose is a homopolymer of  $\beta$ -D-glucopyranose subunits linked by  $\beta$ -(1,4) glycosidic bonds. These linkages make it a  $\beta$ -1,4 glucan linear chain. This means that the glucose in cellulose is present in the form of cellobiose, which is a disaccharide. A great number of cellulose chains assemble to form a crystalline or paracrystalline network, which is held together by intramolecular and intermolecular hydrogen bonds [20]. A large group of chains forms a cellulose microfibril. These bonds are what gives the cellulose its remarkable strength. Additionally, cellulose has a mixture of amorphous and crystalline regions, the amorphous region being easier to be decomposed by enzymes than the precisely arranged crystalline areas [21].

The cellulose in the lignocellulosic biomass is interlaced with hemicellulose and surrounded with a lignin seal. Because of this complex structure, it is a hard task to directly hydrolyse the lignocellulose [22]. Lignocellulose is well known for the fact that it resists biological, chemical and physical degradation; this property is known as recalcitrance [8]. For these reasons, lignocellulosic biomasses are pre-treated before going to further processing, in order to separate the different components and enabling the obtention of the available sugars via enzymatic or chemical hydrolysis [7].

To maintain consistency with previous studies and be able to compare results, the material to be used in the experiments in this study is pure alpha-cellulose. This differs from lignocellulose as it is only one of the three main

components of it, as seen in this section, and therefore has a simpler structure. Pure cellulose can be directly subjected to enzymatic hydrolysis, which is the process that is being tested in the scope of the "OSCYME" project to evaluate the OFB.

### 2.1.3 Enzymatic conversion

Currently, the conversion of lignocellulosic biomass to fine chemicals and polymers is still in development and has many challenges to overcome. Recalcitrance of lignocellulose is the main reason why the decomposition of it is such a challenge [17]. This makes it difficult to achieve a low-cost degradation of the material to fuels and chemicals. Due to the latter, several pre-treatment methods have been developed over the years to improve the subsequent enzymatic hydrolysis results.

Extensive research is being conducted in order to find ways to overcome the challenges associated to the conversion of lignocellulosic materials into value-added products at economical costs [1]. Among them, efforts are being made to lower the costs of the enzymes that catalyse the lignocellulose [23]. Overall, three processes are needed to convert lignocellulosic biomass into different products. First, pre-treatment of the biomass. Second, enzymatic hydrolysis to obtain fermentable sugars and third, the conversion of the obtained sugars into fuels or bioproducts. In the following sections, pre-treatments and enzymatic hydrolysis will be discussed in more detail.

#### 2.1.3.1 Pre-Treatment

The pre-treatment of lignocellulosic materials is a necessary step for the hydrolysis to have a better glucose yield [4] and, therefore, be an attractive process for the conversion to commodity products. This step aids in the isolation of cellulose, hemicellulose and lignin components, which facilitates the conversion of lignocellulose into fermentable sugars [7]. With pre-treatments the lignin seal is removed, the hemicellulose solubilized and the degree of crystallisation of the cellulose is decreased [22].

In this context, many technologies and methods, which can be physical, chemical or biological, have been investigated since the 1970's in order to prepare the lignocellulosic material. Among them biological pre-treatment with fungi that degrades the material or the widely used Organosolv pre-treatment, a more detailed description of this processes can be found in [7,24]. It has been found that with pre-treatment, the lignocellulosic material can be customized to fit the desired process and achieve a certain product [10], such as ethanol or butanol for example. Advances in the pre-treatment methods and technologies have decreased the cost of this step [25]

After pre-treatment, for the hydrolysis step to be more efficient, it is recommended to wash the pre-treated solid in order to diminish the possible contamination by inhibitors [24]. A better understanding on how different methods for pre-treatment liberate compounds that can act as inhibitors in the downstream process is crucial for the development of lignocellulosic biomass biorefinery.

### 2.1.3.2 Enzymatic Hydrolysis

Cellulose, which, as seen before, accounts for around 40% of lignocellulosic materials, can be hydrolysed to its monomeric form; glucose. This can be done through chemical or biological pathways. Through enzymatic conversion of lignocellulose higher yields of glucose can potentially be obtained at lower energy costs and milder operating conditions, when compared to chemical processes [25]. The focus in this study will be enzymatic hydrolysis, which is a biological process, since it is the process that will be used in the experimental phase.

After the pre-treatment of choice, the cellulose extracted from the lignocellulose goes through enzymatic hydrolysis, where cellulolytic enzymes catalyse the cellulose obtaining a cellulosic hydrolysate as a result of the process. This hydrolysate is composed of a mixture of glucose and pentoses.

The hydrolysis of cellulose involves three main enzymes, namely, endoglucanases (endo-1,4- $\beta$ -glucanase), cellobiohydrolases (exo-1,4- $\beta$ -glucanases), and  $\beta$ -glucosidases [24]. They work together to achieve the complete hydrolysis of cellulose. The endoglucanases (EGs) cut the more amorphous parts of the cellulose in the middle, leaving more free ends exposed. Cellobiohydrolases (CBHs) attack the highly crystalline regions of the cellulose, depolymerising and hydrolysing it. The release of cellooligosaccharides and cellobiose is the major product of this step. The  $\beta$ -glucosidases ( $\beta$ Gs) aim for the freed cellooligosaccharides, hydrolysing it to monomeric glucose [22]. Commercial cellulases combine EGs, CBHs and BGLs to effectively hydrolyse cellulose. The synthesis of the required enzymes is done by aerobic and anaerobic cellulolytic microorganisms, which can be fungi or bacteria.

The group of enzymes that are currently used for the saccharification of cellulose are inhibited by the presence of glucose and cellobiose, which restricts the yield of glucose that can be obtained. [26]. It is logic to think that a higher solid loading (SL) would translate into a higher glucose yield, but a study conducted by Wang et al. [27] suggested that higher solid loadings reduce the cellulase adsorption capacity. An explanation for this is that the inhibition of the enzymes increases along with the solid loading, because the reactions occur faster and a higher amount of glucose is obtained in the liquid fraction [28,29]. The reactor design has an important role and by improving it, the conversion efficiency can be raised.

The main reactions in the enzymatic hydrolysis are the breakdown of cellulose by CBH and EG into cellobiose (path 1, fig 3) followed by the catalytic cleave of cellobiose into glucose by  $\beta$ Gs (path 2, fig 3). Among the components that cause inhibition in enzymatic hydrolysis of lignocellulosic materials, it has been found that both glucose and cellobiose, which are products, are two of the main ones. Cellulolytic enzymes are inhibited by both glucose and cellobiose. Glucose directly inhibits the action of  $\beta$ -glucosidase (path 3 in fig 3), cellobiohydrolases and endogluconases (path 4 in fig 3). Similarly, cellobiose inhibits the cellobiohydrolases and endoglucanases (path 5 in fig 3). At the same time, cellulose exerts some inhibition in CBHs and EGs while cellobiose inhibits in some extent the action of  $\beta$ Gs (seen in path 6 and 7 of fig 3 respectively).

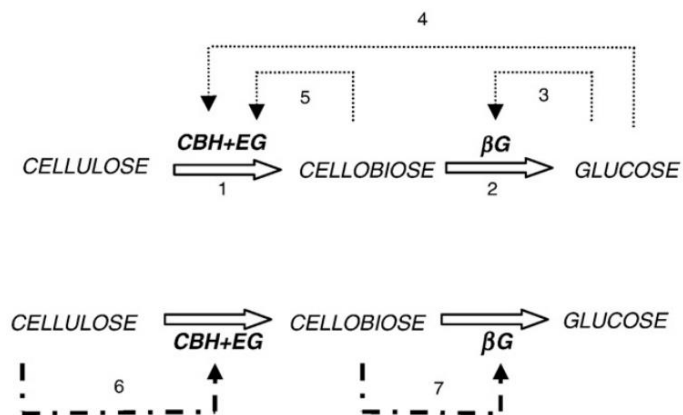

Figure 3. Main reactions and inhibitions during enzymatic hydrolysis. Main reactions (1, 2), glucose inhibition (3, 4), cellobiose inhibition (5), substrate inhibition (6, 7). [30].

Studies on enzymatic hydrolysis have obtained a final glucose concentration that does not surpass 30g/L when applying enzymatic hydrolysis to lignocellulosic materials with solid loadings that are usually less than 10% [27]. A number of different combinations of pre-treatment, and hydrolysis have been tested over the years, using a wide range of substrates and equipment. Regardless of the numerous attempts, in general the total sugar concentration obtained by these approaches is in the range of 30-80 g/L [24].

High enzyme loadings are required per gram of cellulose in order to reach a glucose concentration that is economically viable. Enzyme loadings are typically around 15 FPU/gram cellulose. Enzymes have a high cost and therefore, the high doses needed translate into an increase in the cost of the overall process. This makes the lignocellulosic refining expensive and difficult to commercialize [31]. To tackle the problem of the cost associated to the enzymes, there are two things that can be improved. On one hand, lowering the costs of the enzyme production and on the other, working on the development of mechanisms and technologies for the reaction to need a lower enzyme loading to obtain the desired glucose yields. The mechanisms and factors that limit the hydrolysis are not entirely understood, and there is a need for further research in the area to fully understand how to enhance the obtention of sugars from lignocellulose through enzymatic hydrolysis.

Faster action on solid lignocellulose substrates, enhanced stability and higher specificity of the enzymes that hydrolyse the lignocellulose are some of the upgrades that have been achieved [13], nevertheless, the enzymatic hydrolysis has room for improvement and it is still one of the main obstacles to achieve a cost-effective processing of lignocellulosic materials to value added products [25].

It is through the development of new technologies, such as the oscillatory flow bioreactor, that the effective use of higher solid loadings can be achieved, at the same time reducing the enzyme requirements while improving the glucose yield. Therefore, the reactor design can have a great impact reducing the costs of the process.

### *2.1.3.3 Enzyme-substrate binding*

The inhibitions mentioned in the previous section lower the glucose yield. It is known as product inhibition, which happens when the substrate binding capacity of the enzyme is decreased with a higher product concentration. This means that during the extent of reaction, as more glucose is being produced, the more the enzymes are inhibited. This affects the reaction rates and extends the duration of the reaction.

Additionally, the enzyme substrate ratio (E/S) was identified as another important parameter when it comes to inhibitions and substrate binding. When E/S is relatively high, it can happen that the reactive sites in the substrate saturate with enzyme and even a part of the enzymes could be found in the solution. This can cause a competitive or semi-competitive inhibition, since the enzyme's opportunities to participate in the catalysis of the substrate is dependent on the available space to bind to the surface of the cellulose [30]. The rate of the hydrolysis is affected as well, due to the non-productive binding of the enzymes to the substrate, this happens when they adsorb to the substrate but are not active, at least temporarily. This prevents the action of active enzymes in the cellulose. This latter effect is known as competitive enzyme-substrate binding [32]. Adding more substrate should reduce this problem and create more glucose, but then the inhibition might be caused by the presence of glucose and cellobiose, as seen in the previous section.

In general, the adsorption and binding of the enzymes to the lignocellulosic materials is complex due to the heterogeneity of the substrate, having different crystallinities and chemical compositions. The cellulase adsorption into the substrate takes place in the first stages of the hydrolysis [33]. It has been shown that the cellulase adsorption process is fast at the start of the hydrolysis, when the product concentration is low [34]. However, there are variety of studies on enzyme binding and the inhibitions that occur during the hydrolysis leading to different results and findings, therefore, there is still a need for a better understanding on the interactions between enzyme, substrate and products for the case of the enzymatic hydrolysis of cellulose and lignocellulosic materials. By understanding these mechanisms, the hydrolysis can be optimized to yield a higher concentration of product with lowest costs in materials and energy.



## 2.2. Reactors for the processing of lignocellulosic materials

### 2.2.1 Batch and continuous operation of enzymatic processes

The lignocellulosic biomass is commonly processed in batch reactors. A batch process consists of a simple flowsheet employing standard unit operations, such as mixing and heating. A main characteristic of this mode is its flexibility since the configuration can be adapted to fit the needs. The most common type of reactor for this kind of process is a stirred tank reactor (STR), which is composed of a closed tank with a motor that is connected to an agitator, mixing the materials in the tank (fig 4). Other types of reactors that can be used are tubular reactors.

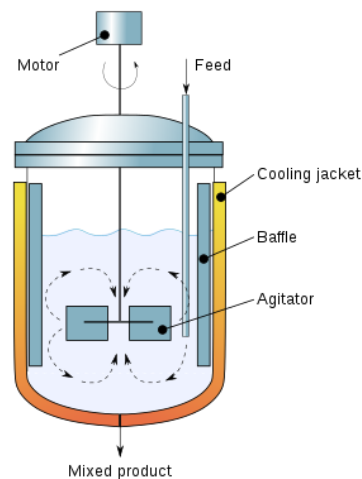

Figure 4. Stirred tank reactor, diagram by Daniele Pugliese.

A process which has a higher productivity than batch is a continuous process. In this case the material is carried as a flowing stream, usually with the reactants being fed continuously to the system while the products are being extracted.

### 2.2.2 Oscillatory flow bioreactor

As mentioned in the previous chapters, the processing of lignocellulosic biomass has challenges to overcome. Existing technologies such as the stirred tank reactors, are not yet able to solve some of the problems that emerge in the processing of the biomass, such as the inhibitory reactions caused by the accumulation of glucose and cellobiose. In order to potentially overcome this main issue, a new type of reactor is needed, where a continuous mode can be implemented, removing the products to restrain the inhibition effects.

One of the innovative concepts for reactors is the continuous oscillatory baffled reactor (COBR). This type of reactor has a tubular shape, where a baffle is situated on the inside of the reactor and the fluid in it is submitted to an oscillation. The fluid oscillates and bumps into the baffle, where the mixing is induced by the formation of eddies. This allows the net flow to be uncoupled from mixing, allowing longer residence times which is good for long reactions. By controlling the oscillatory movement, the degree of mixing can be adjusted [35]. In order to avoid the

sedimentation of the cellulosic material and to achieve suitable conversion rates, it is necessary to have a sufficient mixing that can ensure homogeneity in the solid-liquid suspension. A good mixing provides the enzymes with good access to the substrate and can also remove some of the reaction limiting concentration gradients. Additionally, using technologies that incorporate an oscillatory baffled reactor has proven to reduce the power density needed to enzymatically hydrolyse alpha cellulose to 94-99% for maximum conversion rates when compared to a stirred tank reactor [36].

A large amount of the costs in enzymatic hydrolysis are linked to the quantity of enzyme needed in order to reach viable glucose concentrations and the fact that the reaction rate is naturally slow. High enzyme amounts are needed to perform a commercial hydrolysis, reaching dosages of 15 FPU per gram of cellulose [25]. Diminishing the enzyme requirement would further reduce the costs of the system.

Considering all the above-mentioned aspects, a continuous oscillatory flow reactor concept, named Oscyme for effective hydrolysis of lignocellulosic materials was set-up in the early stages of the project. This oscillatory baffled reactor (OBR) was designed specifically for bioprocesses. Preliminary tests to evaluate the flow and mixing behaviour were conducted at the University of Newcastle in order to optimize the process conditions. This was followed by enzymatic tests performed at AEE INTEC with the OFB pilot plant [5]. Among the findings, it was identified that the best baffle was the helical baffle, as opposed to single and multiple orifices baffles, since it provided a good mixing quality when combined with the oscillatory movement. The baffle types can be seen in figure 5.

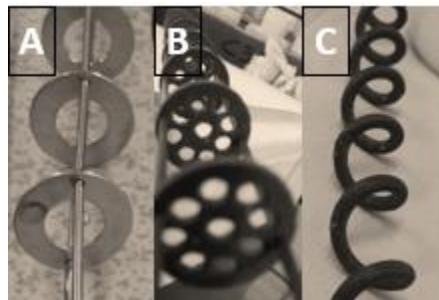

Figure 5. Baffle types. A. Single orifice, B. Multi-orifice and C. Helical baffle.

A plug flow characteristic is reached in continuous mode OBR which is beneficial for the reaction [37]. The swirl flows combined with vortices make the plug flow possible for a wider range of flow movements with Reynolds numbers between 50 and 800. The modular jacketed reactor that was designed and used in this study is seen in figure 6.



Figure 6. Oscillatory flow bioreactor jacketed module.

### 2.2.2.1 OFB Operation

In conventional tube reactors, turbulent flow regimes are usually induced by higher flow rates, this results in lower residence times which are conditioned by the length of the reactor. The desired turbulence can be achieved in an OBR with the oscillation, providing a better mixing and since the net flow conditions can be disjoined a better residence time distribution can be reached in order to process long reactions. Additionally, the adjusting of the conditions for the oscillation parameters can set different mixing conditions [38]. In general, the chemical conversion of large amounts of materials is more economical and feasible in reactors that have a continuous regime in contrast with batch reactors [39].

Using an OBR in continuous mode has shown to have a higher degree of plug flow characteristics, using a helical baffle. This effect is beneficial for the mixing and is achieved by a combination of swirl flows and vortices [37]. The plug flow effect in an OBR is reached for Reynold numbers ranging from 50 to 800, which is strongly linked to the oscillatory amplitude which affects the flow characteristics. A plug flow is different from laminar flow and turbulent flow, and does not have a radial velocity gradient, which means every particle in the flow experiences the same residence time. The difference between turbulent, laminar and plug flow can be seen in figure 7, where  $u$  stands for flow velocity.

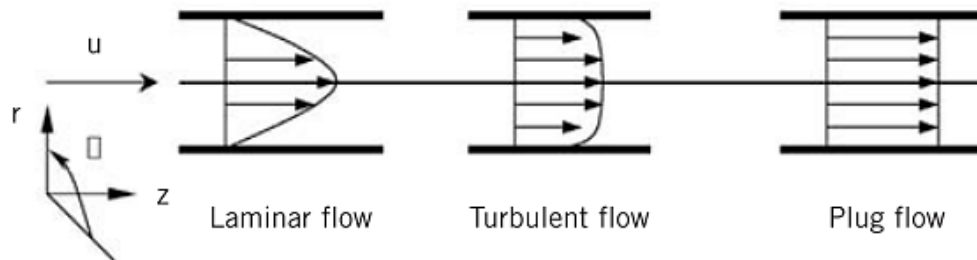

Figure 7. Different types of flow and their explanatory illustration by [35].

### 2.2.2.2 Design

The basic design of an OBR is composed by a baffled tube with diameters that vary in the range of 10-150 mm and a pump with a piston to create the oscillatory movement in one end of the tube. That is the basic equipment needed for batch operation. To change the set up to continuous mode, it is necessary to integrate a new element, a net flow pump. Ideally, the system should be designed with the same diameter along all components, reactor tube, pumps and additional pipes and bends that are needed. This makes the mixing conditions optimal, generating eddies and vortices in the direction of the fluid moving with oscillations.

Using an OBR in batch configuration a homogeneous mixing can be reached. On the other hand, OBRs in continuous mode could achieve steady state. There are several ways to design an OBR, using different types of baffles and assembling the system in varied set ups.

Each time the fluid oscillates inside the OBR, the flow causes a cascade of vortices that dissipate and lead to axial and radial velocities in the same range [40]. The use of baffles and oscillatory movement allows an efficient mass transfer and heat transfer, due to the flow pattern that is generated [41]. It is possible to have long residence times in the continuous mode configuration, which is a great characteristic to perform long reactions [42].

### 2.2.2.3 Mixing

A good mixing quality is a key precondition for several chemical and biotechnological processes, since it eliminates inappropriate gradients and, at the same time, improves the mass and heat transfer. The mechanism of stirring is vastly studied and has been described in common literature. A combination of the Reynolds number and other dimensionless numbers provide a solid framework to characterize flow regimes and shear conditions. By introducing the oscillations with a pump, a good mixing quality with low shear rates can be possible to reach, due to the forming of extending vortices in the areas between the baffle. Therefore, the mixing degree can be adjusted by changing the oscillatory frequency or amplitude quite easily and despite of the flow velocity, since these are the factors that define the overall mixing intensity in the system.

The sharp edges of the baffle stall the reversing flow caused by the oscillation, which results in a cascade of vortices. The repeating motion generates two half cycles, accelerating and decelerating the flow in phases. Flow acceleration is characterized by the formation of vortices downstream of the baffles, while in the deceleration phase, the vortices fade into the rest of the flow and then regenerate in the opposite direction with a restored acceleration. Through this repetitive phases is how a homogeneous mixing is achieved in the series of inter-baffle zones along the reactor length, by strong radial velocities encountering similar axial flow velocities [43]. During the acceleration in continuous mode operating of an OBR, the vortices grow in furrows behind the baffle constrictions until they fade out in the mainstream flow, decelerating [44]. The behaviour of the flow in the OBR is schematized in figure 8.

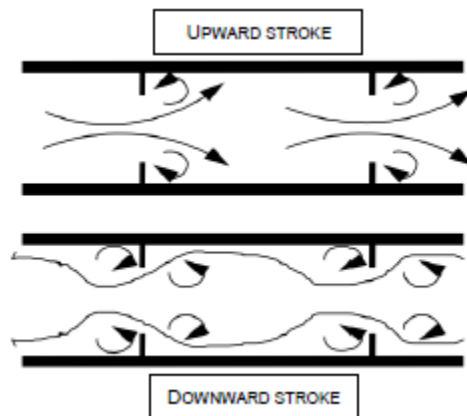

Figure 8. Upward and downward stroke scheme [5].

With respect to the baffle type, helical baffles provide a better mixing due to the combination of swirling flows and vortices it generates. It has been shown that the swirling flows aids in the limitation of the axial dispersion [37,40].

Additionally, the rounded shape of the baffle has proved to reduce the deposits of cellulose during the mixing operations in the preliminary experiments conducted in UNEW. The absence of flat exposed surfaces is the explanation for this.

### 2.2.3 Intensification Potential

The intensification potential of bioconversion processes is high, due to the fact that most of these processes take place in stirred tank reactors, often in batch mode. The limitations of STRs are well known and have been studied and identified in literature and, therefore, there is a lot of room for improvement.

As previously discussed, the process of converting lignocellulosic materials into fermentable sugars via enzymatic hydrolysis is a slow reaction. For this reason, conventional tubular reactors are not adequate since the mixing degree that is reached is not suitable for long reactions to take place. This translates into low residence times, not optimal for the lignocellulose saccharification.

The use of OBRs in continuous mode can potentially be the solution for these limitations, adding the oscillations and the baffle enhances the mixing while increasing the residence time, and has the flexibility to be configured both in batch mode and in a more productive continuous mode, the being a better match for long reactions [42,45]. Furthermore, the mixing in the OBRs is not dependent on the net flow, which means that smaller reactor sizes are effective [41].

The OBR can potentially increase heat transfer, mass transfer and multiphase mixing in continuous operations [40,46]. The plug flows characteristics it can achieve, makes the reactor more practical, with an efficient mixing both in radial and axial direction [47] as well as decoupling the net flow from the oscillatory flow. The fact that the oscillatory mixing and velocity are good, means the net flow velocity can be low. This characteristic is interesting for reactions that require a long residence time, since this makes the design of a reactor more feasible, needing smaller length to diameter ratios.

For the purpose of this study, the enzymatic hydrolysis will be tested in three types of processes: two in batch, one being in a stirred tank reactor and another with the OFB, and one with the OFB reactor but in a continuous mode. The configuration for each system will be described in the experimental chapter.

## 3. Experimental

### 3.1 Oscillatory flow bioreactor

The Oscillatory Flow Bioreactor (OFB) was specifically designed within the “Oscyme” project with the goal of processing bio-slurries containing up to 18% w/v solid loadings of cellulosic materials. The concept is based on studies on OBR technology [40–42] and experimental studies have been conducted at the University of Newcastle [36,48] as well as the first experimental conducted in the pilot plant located at AEE INTEC. The aim of this work is to extend the testing series and set an appropriate layout for the plant in continuous mode, running tests to measure the glucose yield.

The oscillatory power depends on the set frequency and amplitude on the oscillatory pump, therefore, by regulating these parameters the overall mixing quality can be determined. This is the main feature of the OBR systems and it is an important characteristic that was incorporated in the design of the OFB. The OFB pilot plant concept was designed for continuous enzymatic processing of lignocellulosic materials, using low net flows and at the same time providing a good mixing by introducing the plug flow behaviour that was previously discussed. The plant is expected to achieve high mixing quality and homogeneity by using low energy inputs, with the possibility of integrating waste heat recovery to the heat exchanger. The laboratory plant scheme is shown in figure 9.

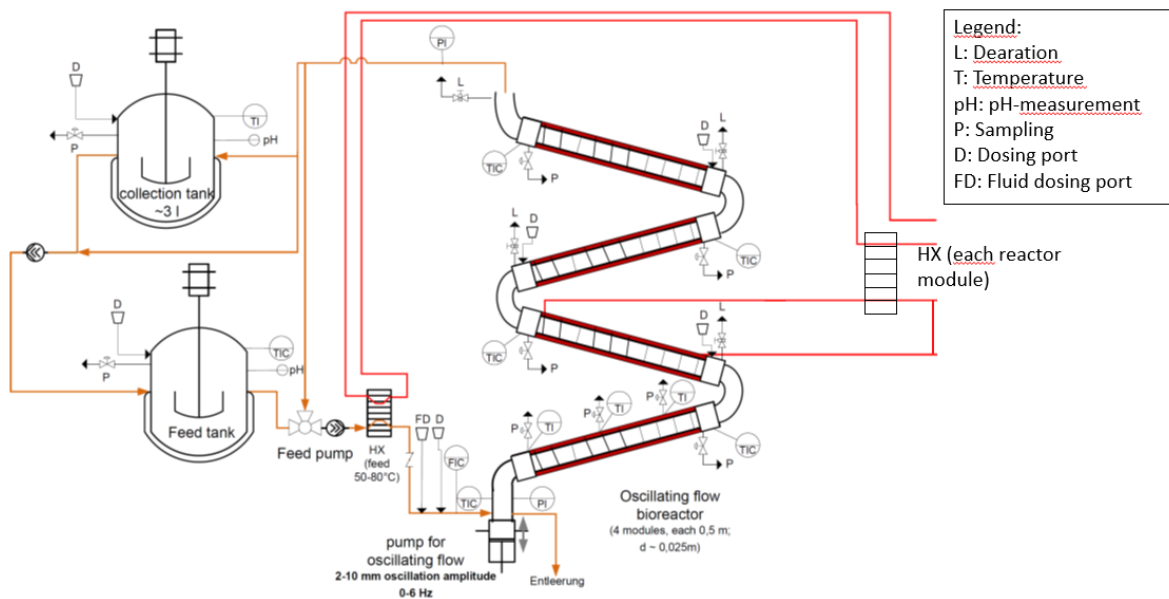
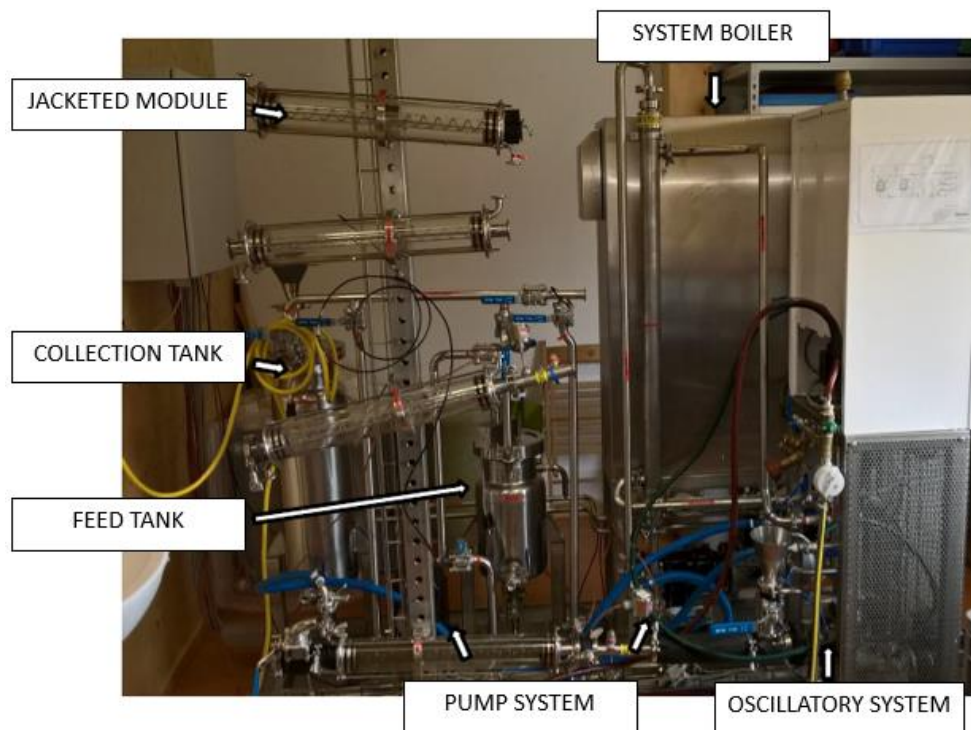

Figure 9. Laboratory plant scheme of the OFB.

The pilot plant was constructed by Möstl Anlagenbau, which is one of Austria’s leading manufacturer of plant engineering for pharmaceutical and food industry. The designed plant was based on the observations and results gathered during the pre-testing stage for OBR at UNEW and the concept of the plant is modular, in order to facilitate the rearrangement of the equipment to fit different set-ups and layouts.

The plant is composed of four jacketed OFB modules that are heatable and their positions can be adjusted in angle and inclination. A closed heating system was incorporated to maintain a constant temperature through the system. Additionally, a circular pump system is in charge of both the substrate feed and the product collection.

Each OFB module has a glassy heating jacket and has a cylindrical shape measuring 62 cm in length. The inner tube is where the reactions take place, it is made out of acrylic glass and has a diameter of 22,5 mm. The helical baffle is situated inside the inner tube, with a diameter of 2 mm and made out of wire. An electric sealed system boiler is in charge of heating the water that flows through the closed heating system. The modular parts are put together by clamps that tightly close with a rubber that seals the connection between the different parts. This makes it easy to arrange the parts and modules in different ways adjusting them to different configurations. The bioreactors can be screwed to a firm position in a variety of angles by big hand screws in a metal stand, seen in figure 10.



*Figure 10. OFB pilot plant with one module connected.*

During this study, only one jacketed OFB module was used. A first set of experiments was conducted using a batch set up, testing two different methods of enzyme addition and sampling in two areas of the reactor. The configuration of the system was then changed to fit a continuous mode set up connecting a net flow pump to the system and samples were taken to measure the glucose yield in the reactor.

The OFB plant could be easily monitored and operated by a central software that was specifically designed for it. The main operating units such as the heating system and oscillatory pump, could be controlled and the power of the engines were able to be set precisely in percentage numbers. Temperature monitoring systems were installed to

make sure the appropriate temperature was kept on the system. The system boiler and peristaltic pump could also be monitored and controlled through the software, being able to heat the water at the desired temperature and pump the flow through the system at the desired velocity respectively. Additionally, two tanks that could be heated up were a part of the system as well but were not used in the scope of this study. The user interface is shown in figure 11.

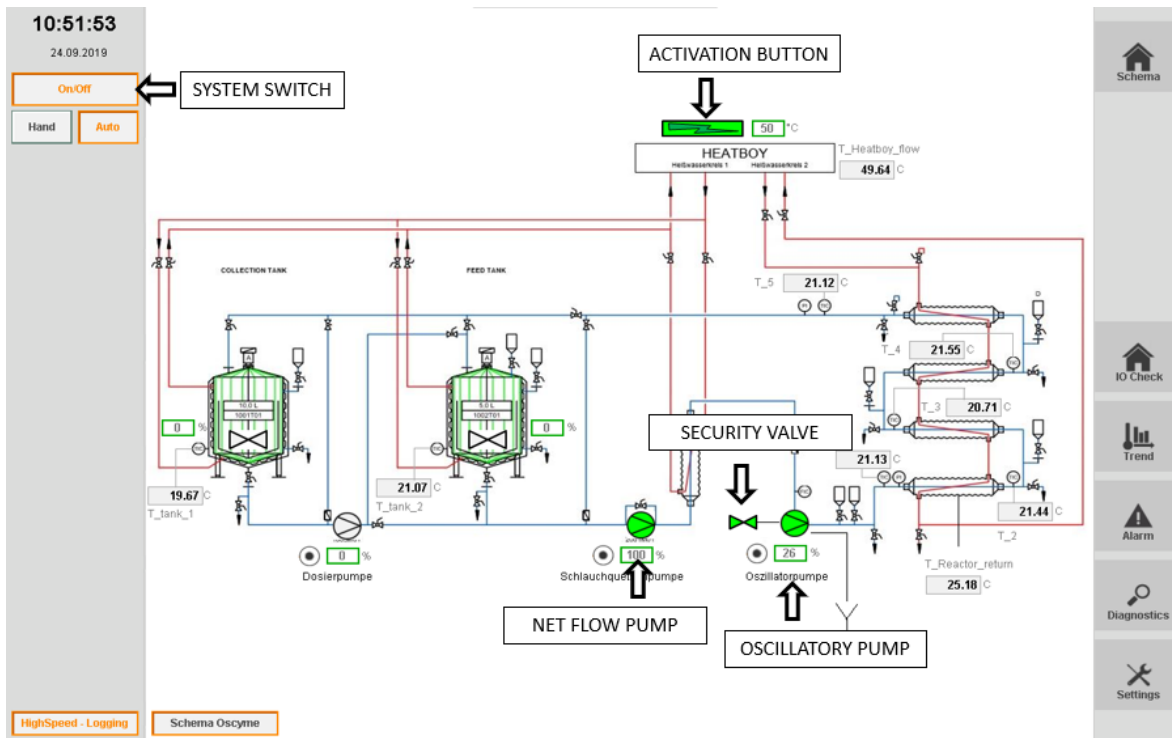

Figure 11. Laboratory scheme of the OFB plant.

### 3.1.1 Oscillatory pump

The oscillatory pump is what makes the biggest difference among the OFB and other OBR systems, the incorporation of an oscillation to the movement of the flow, as discussed before, has a great impact in the quality of the mixing. To achieve the oscillatory movement, a reciprocating pump was installed in the system. A connecting rod with a piston was mounted into a rotational disc to generate the movement. The piston was moved by an electrical engine unit that consisted of an electric motor that was coupled to a mechanical gear box. In order to ensure the duration of the equipment and a smooth operation, the piston was being lubricated constantly by a continuous stream of water, which also served to keep a cool temperature in the piston area.

The frequency was calculated and adjusted on the previous work by counting the disc rotations per minute occurring with a determined engine power number. It was found that a ratio of 0.0683 rps/% of engine power number was constant. This ratio was used to calculate the oscillatory frequencies by establishing an equation to relate them to engine power, equation (1) [5].



$$f = P_{num} * 2 * 0,0683 \quad (1)$$

$f$  ... Frequency of oscillation [Hz]

$P_{num}$  ... Engine power number [%]

The results of said calculations can be seen in table 1. On the other hand, the amplitudes were regulated by the choice of rotational plate disc, which were in the range of 4 to 20 mm hub specification. The amplitude and the frequency defined the oscillatory power. In this project, three different frequencies were used; 1,09 Hz, 2,05 Hz and 3,55 Hz and the amplitude used was always 10 mm.

Table 1. Applicable oscillatory frequencies correlated to the adjustable engine power numbers.

$P_{num}$	$f$	$P_{num}$	$f$	$P_{num}$	$f$	$P_{num}$	$f$	$P_{num}$	$f$
[%]	[Hz]	[%]	[Hz]	[%]	[Hz]	[%]	[Hz]	[%]	[Hz]
1	0,14	16	2,19	31	4,23	46	6,28	61	8,33
2	0,27	17	2,32	32	4,37	47	6,42	62	8,47
3	0,41	18	2,46	33	4,51	48	6,56	63	8,61
4	0,55	19	2,59	34	4,64	49	6,69	64	8,74
5	0,68	20	2,73	35	4,78	50	6,83	65	8,88
6	0,82	21	2,87	36	4,92	51	6,97	66	9,02
7	0,96	22	3,01	37	5,05	52	7,1	67	9,15
8	1,09	23	3,14	38	5,19	53	7,24	68	9,29
9	1,23	24	3,28	39	5,33	54	7,38	69	9,43
10	1,37	25	3,41	40	5,46	55	7,51	70	9,56
11	1,50	26	3,55	41	5,6	56	7,65	71	9,7
12	1,64	27	3,69	42	5,74	57	7,79	72	9,84
13	1,78	28	3,82	43	5,87	58	7,92	73	9,97
14	1,91	29	3,96	44	6,01	59	8,06	74	10,11
15	2,05	30	4,10	45	6,15	60	8,2	75	10,25

It is important to mention that the control electronics of all operating units was installed inside the same electronic control box and it included a main power meter that could monitor the power consumption of the plant accurately. Additionally, the power consumption of the different operating units could be monitored individually thanks to the installation of seven bypass power meters. The recorded power consumption could be accessed through the software system in real time and the data could be downloaded per day of function of the system.

### 3.1.2. Modular design

The OFB pilot plant was designed to be modular, to facilitate the use and to make it easy to adapt the system in different layouts and configurations. In order to describe the different configurations and make them replicable, the available parts of the system were labelled in the previous work as presented in figure 12. An open side was always left with the purpose of filling the system and obtaining samples, this was achieved by using parts such as D or G in the upper part of the reactor.

Hand clamps were available in two sizes (I and J in figure 12), making it possible to assemble all desired parts together. To seal the system properly, a rubber ring was placed in between the two parts to unite, and then the clamp surrounding the two parts was firmly tightened. The different configurations that were used for batch and continuous mode are described with a picture and additionally for the continuous mode with the modular parts to make it easier to replicate the layouts if needed, starting from the oscillatory pump until the end of the system in the case of batch, or until it re-enters the oscillatory pump for the case of continuous mode. The letter M was assigned for one jacketed module of the OFB.

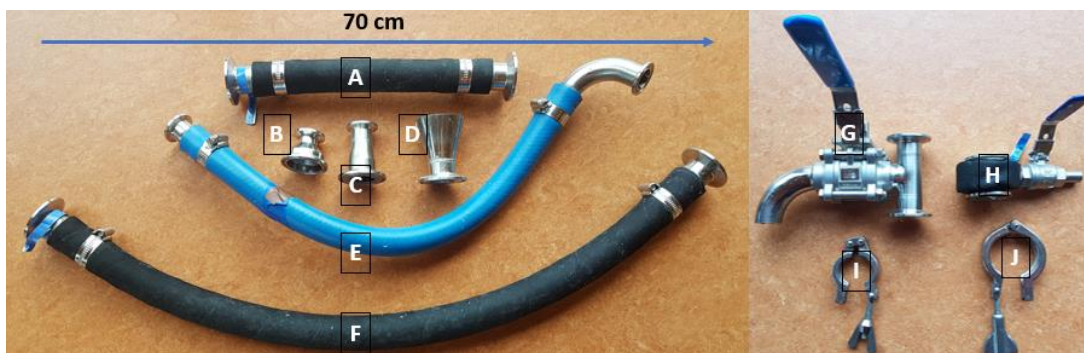

Figure 12. Modular parts, some partly insulated.

#### 3.1.2.1 Batch Configuration

In the beginning of the work, the OFB plant was configured to conduct batch experiments. In this case, the modular parts connected were the ones seen in figure 13, which is the basic structure for the continuous configuration as well. Starting from the oscillatory pump the configuration is as follows; T-L-H-M-D, D enabling the filling of the reactor and the obtention of the samples. A temperature sensor was placed in the centre of the jacketed module to make sure the temperature was kept somewhat constant and as close to 50°C as possible, given the effect of the ambient temperature. The net flow pump was not connected in this case and the total volume of the system reached 550 ml.



*Figure 13. OFB batch configuration.*

### *3.1.2.2 Continuous Configuration*

It is important to clarify that for this study, the continuous mode is related to the presence of a constant flow, not to the continuous input of materials and withdrawal of products. To test the hydrolysis conversion in continuous mode, a different set up was laid. The net flow pump was integrated to the system to generate a constant flow and mimic a continuous mode operation. As well as in batch mode, only one jacketed module was used. The configuration was extended, taking the same as in batch mode but extended with other modular components seen in figure 12, connecting the module to the net flow pump and the net flow pump to the oscillatory pump.

The total volume of the system was of 1100 ml. This set up is seen from two angles in figure 14. Additionally, to keep the temperature constant along the whole system, flexible pipes with water flowing from the heated system were incorporated, surrounding the pipes and connections of the system.

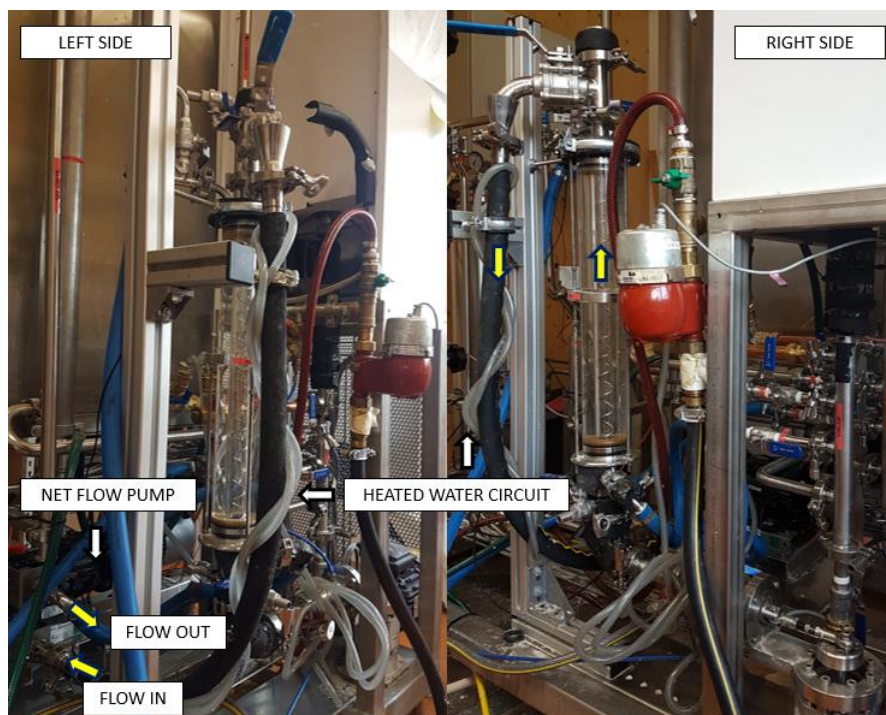

Figure 14. OFB continuous mode configuration as seen from the left side and the right side.

## 3.2 Materials

### 3.2.1 Laboratory equipment

Table 2. Laboratory equipment.

Instrument	Specification
OFB pilot plant	Mösti
Precision balance, Entris 6231S-1S	Sartorius Lab Instruments GmbH & Co
Magnetic Stirrer, Variomag Mono Direct	H+P Labortechnik AG
Portable density meter, DMA 35	Anton Paar GmbH
Multimeter, WTW Handheld 340i plus pH-Electrode SenTix 21-3	Xylem Analytics Germany Sales GmbH & Co.KG
Laboratory stirrer SLR	Xylem Analytics Germany Sales GmbH & Co.KG
Vaccum Membrane Pump 230 V	Bartelt GmbH

### 3.2.2 Chemicals

Table 3. Chemicals.

<b>Chemicals</b>	<b>Specification</b>
<b>Citric Acid monohydrate</b>	Roth, 1818.1
<b>Tri-Sodium citrate dihydrate,</b>	Merck,1,06432
<b>D-(+)-Glucose</b>	Sigma, G7528
<b>Cellic Ctec2 cellulase mix</b>	Sigma, SAE0020
<b>Deionized water</b>	Not specified
<b>Sodium hydroxide</b>	Not specified

### 3.2.3 Other materials

Table 4. Other materials.

<b>Material</b>	<b>Specification</b>
<b><math>\alpha</math> - Cellulose</b>	Sigma-Aldrich
<b>Centrifuge tubes 50 ml</b>	VWR International GmbH
<b>Filter papers, MN615 in 125, 70 and 110 mm</b>	Macherey-Nagel GmbH Co. KG
<b>Glass bottle, Duran laboratory bottle 1000 ml</b>	DWK Life Sciences
<b>Glass beaker, 1000 ml</b>	Not specified
<b>Isopropyl alcohol diluted</b>	Not specified
<b>Pipette, Finnpipette</b>	ThermoLabsystems
<b>Plastic tubes, inner diameter 4mm</b>	Not specified
<b>Syringe, Inject solo 10 ml</b>	B-Braun Austria GmbH
<b>Arbocel</b>	JRS GmbH+Co KG.
<b>Suction bottle for vacuum pump 2000 ml</b>	Bartelt GmbH
<b>Protective sleeve for suction bottles</b>	Bartelt GmbH
<b>Büchner funnel, 77mm and 125 mm</b>	Bartelt GmbH
<b>Disposable aluminium weighing dishes</b>	Not specified

## 3.3 Methodology

### 3.3.1 Experimental Procedure

To prepare for the experiments, 50mM citrate buffer was first prepared and stored in a fridge. The buffer was prepared with 21.94 g of citric acid monohydrate and 42,81 g of tri-sodium citrate dihydrate for a volume of 5 L. The chemicals were first dissolved in one litre of deionized water with the help of a magnetic stirrer. Once 80% of the requested volume was reached, the pH – value was adjusted to 4,8 with 5M NaOH, then the last litre was poured into the container. Up to 10 L of buffer were stored in the fridge at a given time. In the same fridge, the enzyme bottles were stored to preserve them.

Once the desired system was set-up, the first thing was to switch on the water heating circuit to regulate the temperature in the jacketed module, setting the temperature in the software. The water jet for the oscillatory pump lubrication was then opened to enable the use of both the oscillatory pump and net flow pump. The oscillatory pump and the net flow pump desired engine power in percentage was entered in the system. While the system was heating up, the buffer was pre-heated to 50°C in the laboratory stirrer, stirring with a magnet to even out the temperature throughout the glass beaker. The cellulose was weighted and mixed with the buffer once it reached 50°C. The solid loading was defined as 11-12% for most of the experiments. This was the usual procedure followed for all experiments, both in batch and continuous mode. Experiments that lasted up to 45 hrs were conducted, with focus on 24-hour experiments. To clean the system, once the experiment was concluded, the system was emptied with the oscillatory pump still running and net flow pump in case of a continuous mode. Then, the system was filled with water while the oscillation helped to remove the particles that remained in the system. Finally, the system was emptied and occasionally completely disassembled to thoroughly clean it. The heating and pumps were then shut down and the water flow for lubrication closed.

#### 3.3.1.1 *Batch mode procedure*

In the case of the batch configuration, once the buffer was mixed with the cellulose and the system pre-heated at 50°C, the oscillatory pump was activated. There were two methods used for the enzyme addition.

In the first case, the enzyme was added directly inside the reactor when the system was already running. Once the system was full, the previously calculated amount of enzyme (10 FPU/g cellulose) was poured directly into the reactor, this time was registered as the start of the reaction.

A second procedure for the enzyme addition was to add the enzyme before pouring the mix into the reactor, namely a pre-addition. The start of the reaction was registered at the moment when the enzyme was added to the buffer-cellulose mix. The buffer with the cellulose and enzyme were manually stirred for mixing and then poured into the reactor. These experiments are noted as PA, for pre-addition of the enzyme.

### 3.3.1.2 Continuous mode procedure

For the continuous mode, the buffer and cellulose mix was poured into the reactor with the oscillatory pump activated. Once the whole system was full, the net flow pump was turned on. The enzyme in this configuration was always added directly into the reactor.

#### 3.3.1.2.1 Ink Experiments

Ink experiments were conducted at different solid concentrations, with two objectives: first, measuring the residence time of the particle and second, identifying the presence of plug flow behaviour. The procedure consisted on the filling of the system with the desired concentration of cellulose diluted in water. Once the system was full and with both the oscillatory and net flow pump running, purple ink was added in one of the open parts of the system and a timer was set to start at that moment. Once the ink was visibly coming from the other end of the reactor, the timer was stopped, and that counted as the measured residence time of the particle. Additionally, the flow was measured at the different concentrations and the residence time was calculated based on the total volume in the system, which was 1100 ml.

### 3.3.2 Experimental Plan

A variety of experiments were conducted in batch and continuous mode. The successful experiments are shown and summarized in table 5. In this table, a letter code is used for batch experiments (given the letter B) and continuous experiments (given the letter C). Additionally, as mentioned before, the method of enzyme addition is noted IA for inline addition, when the enzyme was added directly into the reactor, and PA, as in pre-addition, for when the enzyme was added outside the reactor, in the mixture of cellulose and buffer. In all experiments the oscillatory pump operated at 26% power, meaning 3,55 Hz of frequency, with an amplitude of 10 mm.

Table 5. Experimental plan for both continuous and batch configurations.

Continuous or Batch	Material	Net flow pump power	Total solids	Enzyme addition	Experimental time	N° of experiments	Assigned name for set
C or B	-	[%]	[%]	IA or PA	[hrs]	-	-
B	Cellulose	-	11	IA	5	3	Batch IA
B	Cellulose	-	11	IA	6	1	
B	Cellulose	-	11	IA	7	1	
B	Arbocel	-	11	IA	8	1	Batch AR
B	Cellulose	-	11	PA	6	1	Batch PA
B	Cellulose	-	11	PA	7	1	
B	Cellulose	-	11	IA	24	3	Batch 24
C	Cellulose	100	11	IA	6	1	Conti 1
C	Cellulose	100	11	IA	24	4	Conti 24
C	Cellulose	50	11	IA	24	1	Conti 50
C	Cellulose	100	11	IA	27	1	Conti 27
C	Cellulose	100	11	IA	45	1	Conti 45
C	Cellulose	100	12	IA	27	1	Conti T12



### 3.3.3 Sampling procedure

Samples for hydrolysis were usually taken during the first 6 or 7 hours of the experiment in an hourly basis, sometimes the first half an hour was measured as well. In longer experiments, samples were also taken at 18, 21, 24, 27 and 30 hours of experiment. In both configurations, the samples were extracted with a tube and a syringe from the top of the reactor at two heights, namely the bottom of the reactor, close to the 62cm of length of the module and in the middle of the reactor, at around 31cm. Additionally, for continuous mode, samples were also taken in the open point which was found in the pipe composed of modular parts D-A-F, going into the net flow pump. Each time, between 7-10 ml of sample were extracted, the sample was then poured into a 50ml tube previously prepared with a filter paper, at times with the help of a small funnel. The filtrate was used to measure the amount of glucose using the densimeter. Between measurements, the densimeter was cleaned using room temperature buffer. The filter cakes were usually disposed of, except for the total solid measurements, which will later on be described. The filtrate at room temperature was measured with the densimeter twice, registering the second value along with the temperature. If filtrate was left in the tube, it was disposed of in the biowaste container.

When total solid samples were required, the procedure was to weigh 3 small beakers of the same size, label them and register the correspondent weight. Each beaker was assigned to one sampling port, bottom of the reactor, middle of the reactor and 'inlet' pipe for continuous mode. The samples were then extracted and poured in the correspondent beaker, which was weighed to later calculate the weight of the sample by subtracting the weight of the beaker. Filter paper was weighed before pouring the sample into the tube. The samples were then filtered, and the filter cake was placed in an aluminium weighing dish (previously weighed), labelled and placed into the oven. The filtrate was tested with the densimeter and then discarded. Once all the samples were placed in the oven, they were dried overnight at 80°C. The dried samples were then weighed, and the total solids were calculated.

### 3.3.4 Sampling Analysis and Calibration

The glucose in the filtrate was measured using a densimeter, as mentioned before. This is possible due to the fact that the amount of dissolved sugars defines the density of the solution, as shown by Henderson et al. [49]. For this purpose, a portable density meter was the instrument of choice to measure the density of the filtrates. In order to calculate the glucose amount in the filtrate, the first step was to calibrate the buffer that was used for the experiment with different concentrations of glucose (0, 10, 20, 50 and 100 mg/ml) and generate a calibration curve. It must be noted that the first calibrations (until the 20<sup>th</sup> of March) were done without the previous heating of the buffer, achieving lower densities, due to the fact that part of the glucose was undissolved in the buffer, which is why the procedure was changed. Starting with the 12<sup>th</sup> of April buffer, the buffer was previously warmed to 40°C in order to dissolve the glucose more easily and achieve a uniform solution. In the following graph (figure 15), the calibration of four different 50 mM sodium citrate buffers is shown as an example, with the linear equation correspondent to the buffer prepared the 12<sup>th</sup> of August.



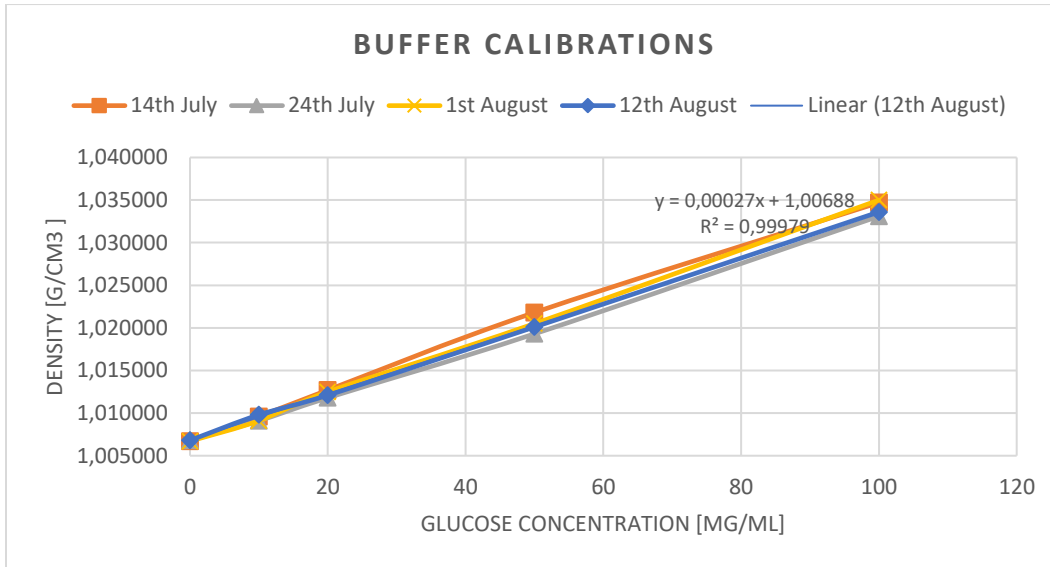

Figure 15. Calibration of different buffers prepared in the labelled dates, with the linear equation for the 12<sup>th</sup> of August as an example.

The density of the pure citrate buffer fluctuated between 1,0058 – 1,0068 g/cm<sup>3</sup>. Other sugars can be present in the filtrate, such as cellobiose, which has a higher density than glucose. If a calibration curve is made considering 50% of glucose and 50% of cellobiose, another s value is obtained, calculated as 0,00037. The linear slope of each calibration curve was used to calculate the sugar mass concentration, in relation to the buffer density and the liquid density, following equation 2.

$$C = (\rho - \rho_{buffer})/s \quad (2)$$

C ...Sugar mass concentration [mg/ml]

$\rho$  ...Liquid density of sample [g/cm<sup>3</sup>]

$\rho_{buffer}$  ...Buffer density [g/cm<sup>3</sup>]

s ...Slope of calibration curve [-]

Measuring density under atmospheric pressure is mainly affected by the temperature of the sample medium and the temperature of the densimeter since properties of materials are changing as well. The resolution for the density meter DMA™ 35 is defined as 0,0001 g/cm<sup>3</sup> for measuring density and the resolution for measuring media temperature is defined as 0.1° C [50].

Therefore, measurement deviations up to 0,0004 g/cm<sup>3</sup> were observed for some samples below 30°C sample temperature including diluting effects in the densimeter. This value corresponds to approximately ±1,08 mg/ml

glucose, what was set as error indication meaning an error below 2 % for common sugar concentrations above 50 mg/ml.

For the STR experiments conducted at ACIB, the measurement technique for the glucose concentration was a DNS based assay, which is often the chosen method for unspecific sugar analysis. In this method the aromatic compound 3,5-Dinitrosalicylic acid interacts in a strong manner with reducing sugars or other reducing agents resulting in 3-amino-5-nitrosalicylic acid. This product is known for its ability to absorb light at 540 nm and therefore spread for a wide range of applications. Respective procedures for analysis of cellulase activities and sugar analysis can be found by [51] for instance.

To verify the accuracy of the DMA measurement, additionally standard sugar solutions were prepared and measured via DMA. The results indicate an error between +4% at concentration of 50 mg/ml to -22% at concentrations of 20 g/ml. DNS assays were performed for the same samples and showed measurement error of -5% to +11% with regard to the standard concentrations.

A similar comparison was done between hydrolysis samples, in order to compare the OFB results measured with the DMA to STR batch tests with DNS assay measurements. Sugar solutions from partial cellulose hydrolysis were drawn at 1,2,3 and 24 hours from a batch OFB hydrolysis tests. DNS and DMA measurements were performed on the same day at identical conditions (sample temperature, room temperature etc.). DNS samples showed a measurement deviation of 6% between duplicates and dilution factors. Table 6 shows the respective measurement results. The variations between DMA and DNS amount to max. 14% in these standard solutions. At higher concentrations of 70mg/ml the DMA actually measured 4% less than the DNS assay.

Table 6. DMA and DNS glucose measurements for 24-hour batch experiment and results variations.

	DNS	DMA			
BATCH 13R	Glucose concentration	Lab sample glucose equivalent	Centrifugated sample glucose equivalent	Difference lab DMA vs DNS	% variation based on DMA
Reaction Time	[mg/ml]	[mg/ml]	[mg/ml]	-	[%]
1h	23,4	28,1	27,5	4,7	17
2h	28,7	34,1	32,5	5,4	16
3h	31,7	36,6	35,6	4,9	13
24h	59,5	67,8	68,1	8,3	12
				<b>Average variation</b>	<b>14</b>

The results of DMA vs. DNS concentrations show that DMA glucose equivalent concentrations were higher than the DNS results in all samples, ranging from 17% at the first sample to 12% at the final 24 hours sample. This might

indicate a decreasing influence of not yet hydrolyzed solid particles in the DMA measurement. The use of an  $s$  value calculated considering that cellobiose is present in 50%, will result in a steeper calibration line and a lower concentration of glucose measured.

For the future comparison of the OFB measurements in this thesis, the average error of 14% is indicated as potential error in all DMA measurement results when compared to DNS measurements in STR hydrolysis. This error potentially reduces all glucose equivalents measured by DMA.

### 3.3.5 Parametric tests

Since two different configurations were used during the experiments, namely batch configuration and continuous configuration, tests were run in order to assess the energy consumption of the system in relation to different frequencies and net flow pump power in percentage. Additionally, since it was the first time using the continuous mode, the system was tested with different cellulose concentrations in order to determine the adequate solid loading to be used in the experiments without causing clogging problems in the net flow pump and to evaluate the flow in ml/min and residence time. Ink experiments were used to determine the residence time and identify plug flow behaviour of the fluid. The tested conditions for batch and continuous mode are presented in table 7.

Table 7. Experiments in continuous mode and batch mode to test energy, total solids and residence time.

Layout of system	Cellulose Solid Loading	Experiment number	Net flow pump (NP) and Oscillatory pump (OSZ)	% engine power	Measurements
Continuous	0% (Water)	VC_W	NP	100,75,50	Power measurements
			OSZ	0	
			NP	100,75,50	
			OSZ	26	
			NP	100,75,50	
			OSZ	15	
			NP	100,75,50	
	5%	VC_I1	NP	100	Ink experiment
			OSZ	26	
	12%	VC_I2.1, VC_I2.2, VC_I2.3	NP	100	Ink experiment, power and total solids
			OSZ	26	
		VC_I3	NP	100	Ink Experiment
			OSZ	15	
	VC_I4	NP	100	Ink Experiment	
		OSZ	8		
15%	VC_I5	NP	100	Ink Experiment	
		OSZ	26		
Batch	12%	B_ETS1	OSZ	26	Total solids

### 3.3.6 Hydrolysis tests

The quantification of the volumetric enzymatic activity of the Cellic Ctec2 cellulase enzyme blend was done in the previous work, using a filter paper assay. This method consists on the incubation of rolled filter paper strips at 50°C in a variety of enzyme dilution factors. The released amount of sugar is then quantified using a 3,5-Dinitrosalicylic acid (DNS) reagent by light absorption at 540 nm. Then, the dilution factors that are known are used to calculate the quantity of enzyme that is needed to release 2 mg of glucose. Filter paper unit (FPU) refers to the moles of sugar released per minute from the use of 1 ml of enzyme, which gives the FPU the dimension of units/ml [52]. The enzyme activity is then measured in FPU. The first batch of enzymes used for the purpose of this project had an enzyme activity of 140 FPU at 50°C, while the second batch of enzymes was found to have a slightly higher activity, corresponding to 144,18 FPU. The enzyme assays were conducted by the project partner ACIB.

Following the previous work, an enzyme loading of 10 FPU of Cellic CTec2 per gram of cellulose was used. A 12g cellulose/100 ml buffer relation was used for the batch experiments (11% w/v solid loading) and for the continuous hydrolysis tests different solid loadings were tested first in the flow experiments during this study in order to determine the appropriate cellulose to buffer ratio that the system could process. To make sure the enzyme was active during the experiments, a constant temperature of 50°C was kept in the system at all times and the buffer was calibrated to have a pH of 4.8.

In this study, the enzymatic hydrolysis was conducted in two different OFB configurations, as mentioned before, batch and continuous mode. The prepared, calibrated and heated to 50°C sodium citrate buffer was in every case mixed with the determined amount of  $\alpha$ -cellulose for each experiment, as described in the experimental procedure. Once the experiment was running, the oscillatory and net flow pump parameters remained constant.

The conversions are given in percentage and are calculated from the amount of glucose formed based on the amount of  $\alpha$ -cellulose applied. While the volumetric enzyme activity of the commercial enzyme product was quantified by ACIB [50] using an FPU assay, the amount of sugar was quantified with a DNS assay for STR experiments using convenient diluting levels.

## 4 Results and Discussion

### 4.1 Batch experiments

For the batch configuration, only one set up was used for all experiments, as described in section 3.1.2.1. Total solids and hydrolysis tests were conducted. Results are seen in the next chapters.

#### 4.1.1 Total solids

In order to assess the distribution of the solids along the length of the reactor, the total solids were measured at two different positions, in the bottom of the reactor (62 cm of length) and in the middle of the reactor (31 cm of length) at three different times. In figure 16 it can be seen that the total solids fluctuate between 8,6% and 10,7%.

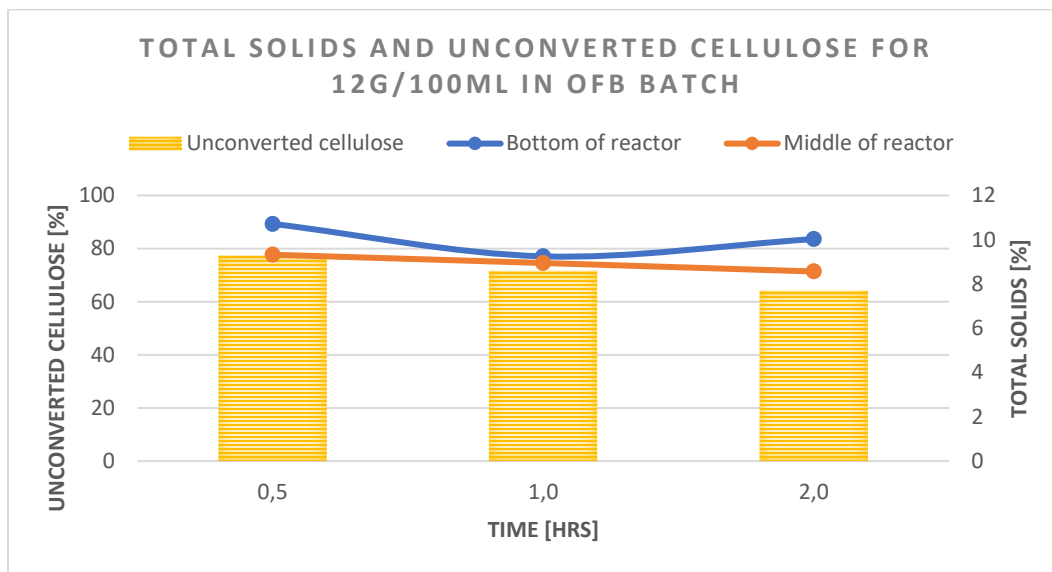

Figure 16. Total solids distribution in OFB batch mode.

As seen in figure 16, the total solids are higher at the bottom of the reactor compared to the middle of the reactor. It must be noted that the reactor is placed in a vertical position, forming a 90° angle between the oscillatory pump and the reactor. The latter could have an influence in the solid's distribution by gravity effects. There seems to be a lower mixing in the bottom of the reactor which might cause an accumulation of particles in this area. More detailed studies on mixing would be needed to explain this particle behaviour.

As time goes by, the total solids diminish, this is expected since the cellulose is reacting with the enzymes and transforming to glucose, passing from solid to liquid form, therefore, the solid loading is decreasing with time, which is the behaviour observed only in the middle of the reactor. The bottom of the reactor shows a different tendency, which is unclear and needs further tests to better understand the behaviour of the mixing and particle residence in said area.

The unconverted cellulose, which is the available cellulose for hydrolysis, diminishes with time, as the hydrolysis takes place converting the cellulose into glucose. The glucose yield, on the other hand, increases with time, as more cellulose has been hydrolysed in the enzymatic reaction.

#### 4.1.2 Hydrolysis

During the experiments, two different methods of adding the enzyme to the cellulose and buffer mixture were tested. On a first approach, the cellulose was mixed with the warmed buffer, mixed by manual stirring. Then the enzyme was added directly into the formed slurry, followed by the pouring of the whole mixture into the reactor. This is noted by PA, for the enzyme added directly into the cellulose. This was the approach utilized in the previous study [5]. The mean results for glucose concentration for this method, Batch PA, and the standard deviation can be seen in figure 17.

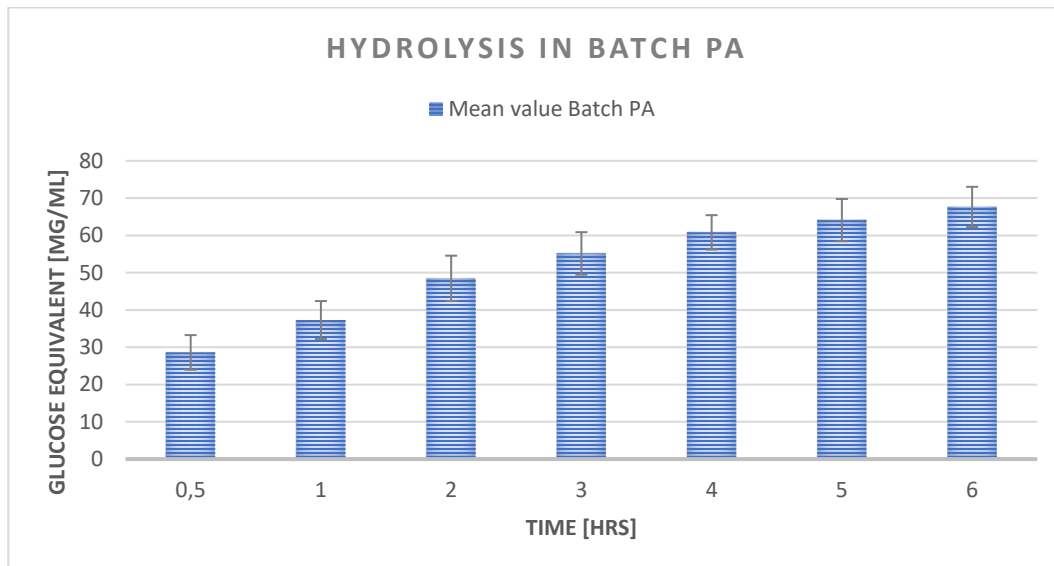

Figure 17. Mean glucose equivalent concentration for pre-addition of enzyme in OFB batch mode.

The maximum concentration of glucose reached using this enzyme addition method was  $74,34 \pm 1,08$  mg/ml for a 12 g/100 ml ratio of cellulose and buffer, which corresponds to a solid loading of 11%, after seven hours of hydrolysis. The error bars show the standard deviation for each hour, having an average standard deviation of 5,3 mg/ml.

On the other hand, the second method involved the addition of the enzyme directly into the reactor that was previously filled with the cellulose-buffer solution. The letters IA are notation for the method of adding the enzyme in the reactor. The results for the hydrolysis for Batch IA experiments are shown in figure 18.

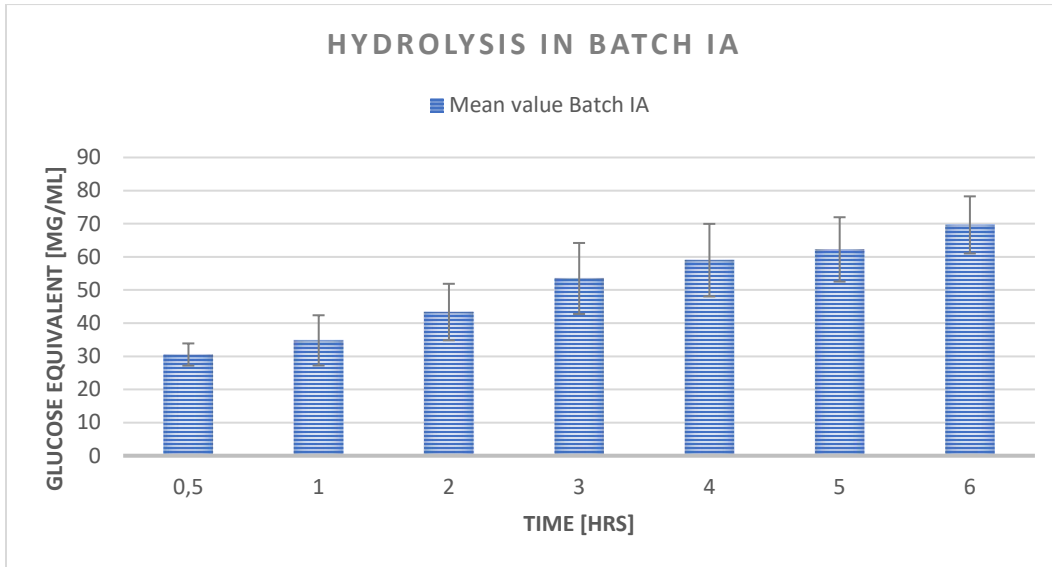

Figure 18. Mean glucose equivalent concentration for inline addition of enzyme in OFB batch mode.

The highest concentration reached with this enzyme addition method was  $80 \pm 1,08$  mg/ml after seven hours of hydrolysis. This is 7,13% higher than with the previous method. Due to this improvement in the glucose yield, it was determined that the method to use for following experiments in continuous mode was the addition of the enzyme in the reactor after the filling of the system with the cellulose-buffer solution mixture. The improvements in the glucose yield can already be perceived in the first 0,5 hour in relation to the pre-addition method. This suggests a possible improvement in the enzyme-substrate binding at the beginning of the reaction.

Additionally, longer experiments were conducted, for 24 hours, to measure the glucose yield and observe the conversion of cellulose in this configuration of the system. Results of experiments Batch 24 can be seen in figure 19.

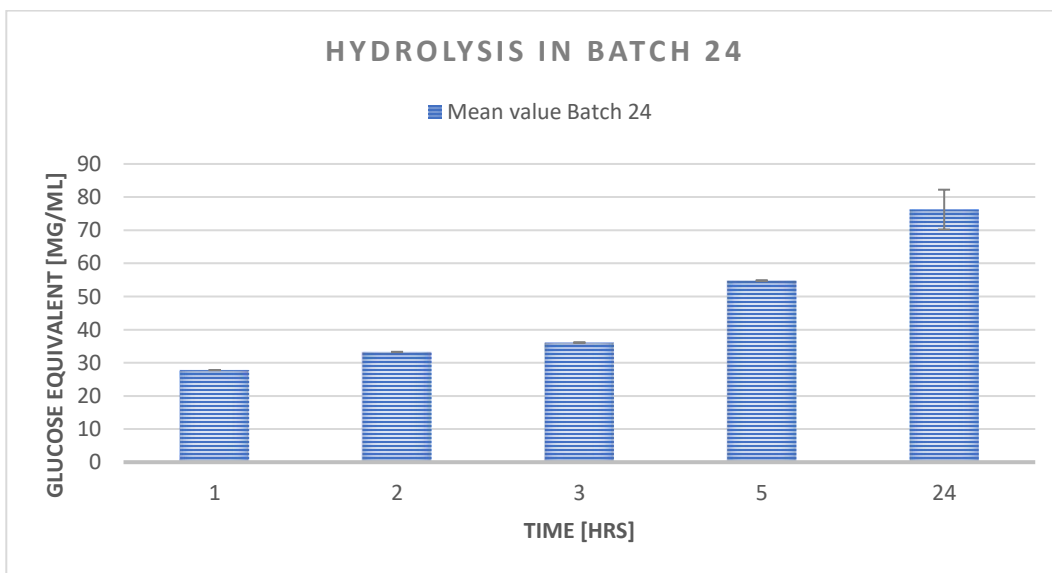

Figure 19. 24-hour hydrolysis of 11% solid loading in OFB batch configuration.

The maximum amount of glucose equivalent obtained with the DMA measurement was  $82,9 \pm 1,08$  mg/ml. This value is very close from that obtained after 7 hours of experiment with inline addition method in batch mode, which shows an improvement of only 3,5% for the 24-hour experiment. This means that in 17 extra hours of experiment, the glucose yield increased by just  $2,9 \pm 1,08$  mg/ml.

It must be noted, that during the work in the laboratory, more than one  $\alpha$ -cellulose package was ordered from sigma-aldrich. It was found that the different batches of  $\alpha$ -cellulose had a mixture of different particle sizes, which varied in proportion. In the case of the Batch 24 experiments, the third experiment was conducted using a different series of  $\alpha$ -cellulose batch in comparison with the two others. The cellulose series and their particle size description can be seen in table 8. In total, three different  $\alpha$ -cellulose orders were used, these are labelled as Original, for the first one used, New, for the second  $\alpha$ -cellulose order and Partner for the cellulose obtained and used from the ACIB laboratory.

*Table 8.  $\alpha$ -cellulose batches and their respective particle composition.*

<b><math>\alpha</math>-cellulose Batch</b>	<b>Retained 35 mesh</b>	<b>Passing 100 mesh</b>	<b>Bulk Density</b>
<b>Original</b>	91,70%	59,60%	3,6 (cc/g)
<b>New</b>	92,40%	65,80%	3,6 (cc/g)
<b>Partner</b>	68,50%	58,50%	3,8 (cc/g)

For the last experiment in batch 24-hour hydrolysis, the cellulose batch Partner was used, while for the previous two, the Original batch was utilized. The third experiment yielded lower glucose equivalent concentrations, reaching  $68,1 \pm 1,08$  mg/ml of glucose equivalent as opposed to  $82,9 \pm 1,08$  mg/ml reached by using the Original  $\alpha$ -cellulose batch. This difference is of 17,8%, which is considerable, and could in part be a result of the different particle sizes in the  $\alpha$ -cellulose batches. Further studies would be needed to understand the influence of the particle size in the enzymatic hydrolysis and therefore, glucose conversion results.

#### *4.1.2.1 Batch experiments versus STR experiments*

Batch experiments were conducted in the scope of this work, while STR experiments were conducted by ACIB. The cellulose (Original) and buffer preparation used are the same for both experiments, as well as the enzyme batch with an FPU of 144. The quantity of enzyme per gram of cellulose added to both experiments is equivalent. In figure 20 the glucose yield for both experiments can be visualized.



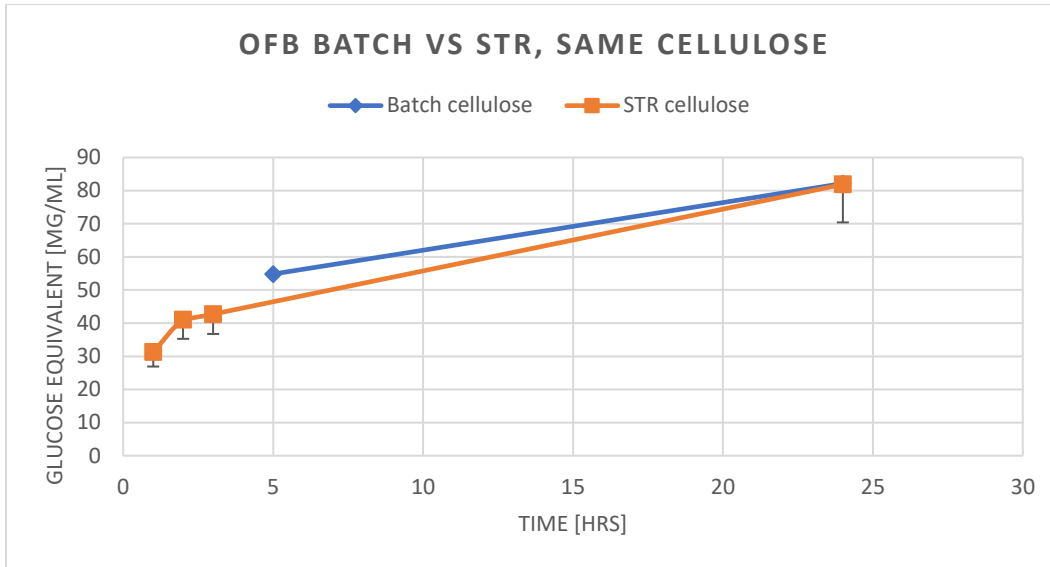

Figure 20. OFB Batch vs STR hydrolysis experiments with Original cellulose.

The figure shows the error bar which corresponds to 14% lower for DMA when compared to DNS. It must be noted that for this experiments the solid loading varies, for the batch experiment it corresponds to 11% and for the STR it is 12%, due to different preparation methods. It is also difficult to compare these results, given the lack of data. What seems clear is the fact that both processes present a different start, but end achieving nearly the same glucose yield, with a conversion of 62% for STR and 68% for OFB batch.

In order to gain a better view of the reaction among the hours, another batch experiment was conducted, but this time with a different series of cellulose, due to the lack of availability of cellulose with the same characteristics as of the Original batch. The cellulose used in this occasion was Partner cellulose, which has different properties than the Original cellulose, with a higher bulk density. The hydrolysis results of OFB batch obtained with Partner cellulose and Original cellulose can be seen in the following graph (figure 21).

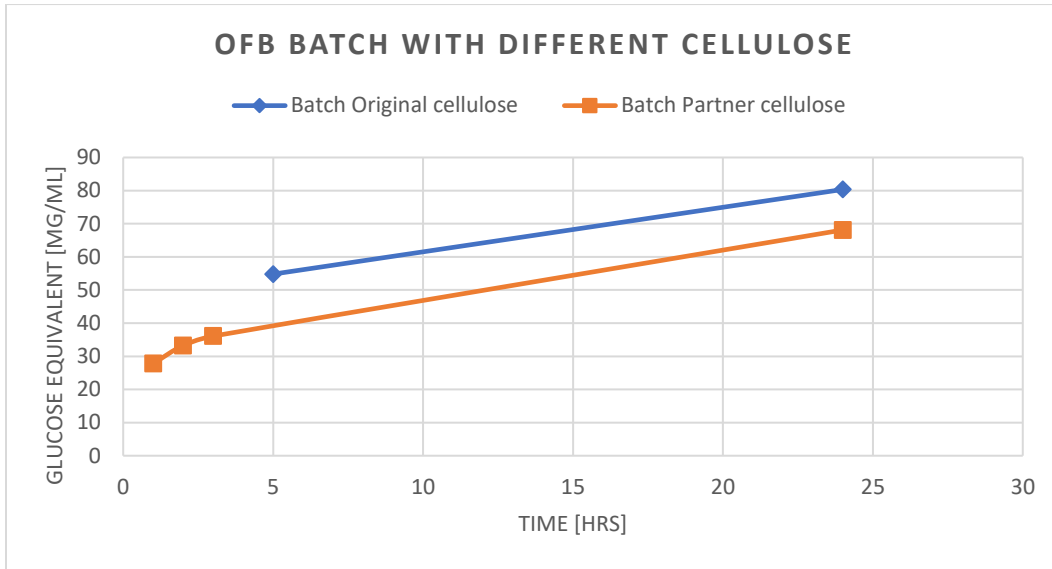

Figure 21. OFB batch hydrolysis with two different types of cellulose.

In figure 21 it is evident that the different types of cellulose have an impact on the glucose equivalent yielded. The main difference between this series of cellulose is the particle size, as seen in table 8. This results in a difference in the maximum yield of 10%. The STR experiment shown in figure 22 corresponds to the same as seen before, performed by ACIB and it is compared to the OFB batch results using the Partner cellulose.

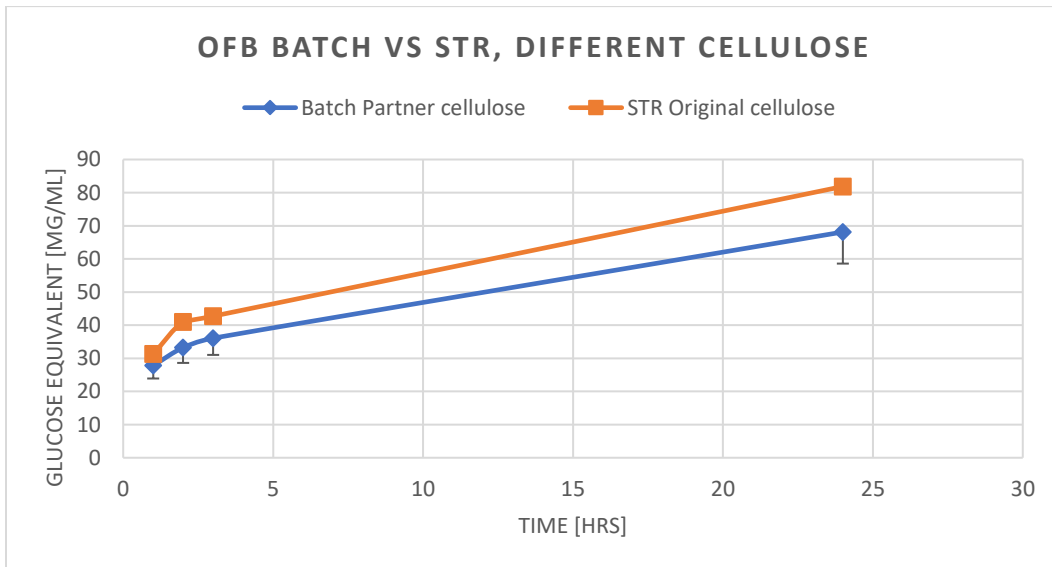

Figure 22. OFB batch with Partner cellulose vs STR with Original cellulose hydrolysis.

This time the results show that the STR has a tendency to increase more rapidly during the first three hours as compared to the batch experiment. It is noticeable once again how the different particle sizes from the Partner batch has an effect on the glucose yield, having a lower yield in OFB batch than in STR reaching just  $68 \pm 1,08$  mg/ml, when as seen in the previous graph, the yield was nearly the same with  $82,9 \pm 1,08$  mg/ml for batch and  $81,9 \pm 1,08$  mg/ml for STR for the Original batch. The effect of particle size in the enzymatic hydrolysis is to be further analysed in future

work. For this reason, to have a proper comparison, the same cellulose batch should be used to perform all experiments, due to the fact that different cellulose batches show different hydrolysis conversion, which might be linked to the difference in particle sizes between the  $\alpha$ -cellulose series.

In addition to the experiments with  $\alpha$ -cellulose, experiments were conducted with another lignocellulose derived material, as noted in the experimental plan, correspondent to Arbocel. This material is composed 99,5% by cellulose, it has a bigger particle size, and can have lignin and hemicellulose as part of its composition. It is plant based and has natural fibre. As a result, it is more difficult to handle than pure  $\alpha$ -cellulose. It also presents a light brown colour, as opposed to the white of the  $\alpha$ -cellulose. Nevertheless, experiments were conducted in OFB batch mode and STR and the results are illustrated in figure 23.

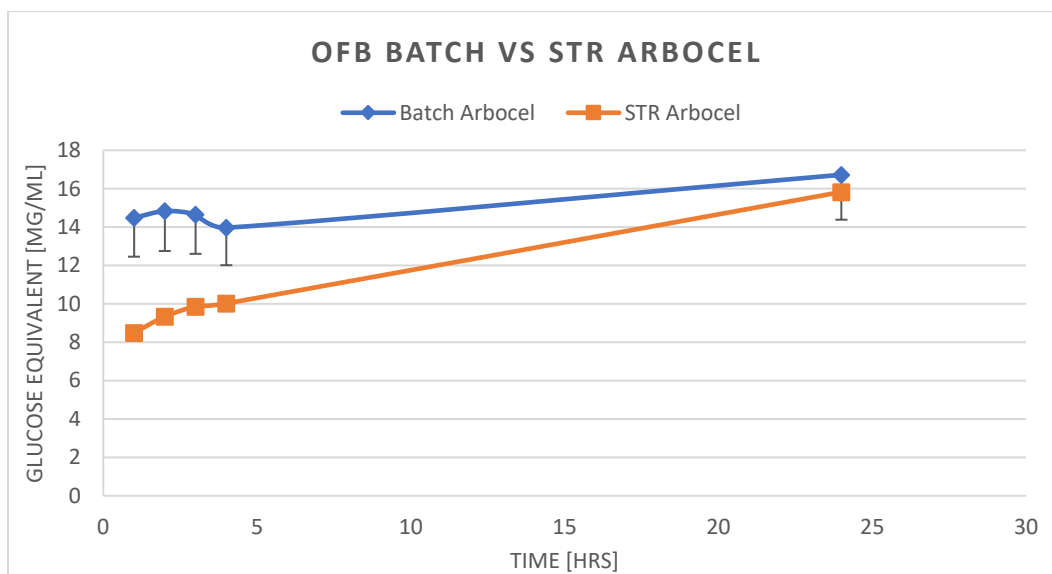

Figure 23. OFB batch vs STR hydrolysis experiments with Arbocel.

As interpreted by the hydrolysis results, Arbocel is also more difficult to treat, yielding considerably lower glucose equivalent concentrations as compared to the enzymatic hydrolysis of  $\alpha$ -cellulose. In figure 24 it can be noticed that when considering the 14% error the glucose equivalent yield is considerably higher for the first hours of experiments in batch mode, but as time approaches the 24-hours, the yield for STR would be higher when taking the 14% error into account. The maximum glucose yield is  $16,9 \pm 1,08$  mg/ml for the OFB batch experiment and  $15,8 \pm 1,08$  mg/ml for the STR.

It appears then that the behaviour is a faster beginning in the STR tank as compared to the batch configuration of the OFB, and then both reactions seem to reach a similar glucose yield, for both cases; cellulose and Arbocel.

## 4.2 Continuous mode experiments

### 4.2.1 Evaluation of Flow Patterns

The flow patterns were assessed by using ink to visualize the flow behaviour in the system. Before the ink was added, the flow was measured at different configurations of the parameters using a slurry of water and cellulose. Setting a timer and measuring the flow by intercepting one end of the system with a beaker, accumulating the mixture of cellulose and water for one minute. The obtained volume was measured and the amount of flow in one minute was obtained and registered. The flow measurements at different solid loadings, net flow pump engine power and frequencies can be seen in table 9.

Table 9. Flow measurements in continuous mode at different parameter configurations.

Experiment number	VC_I1	VC_I2	VC_I3	VC_I4	VC_I5
<b>SL</b>	<b>5%</b>	<b>12%</b>	<b>12%</b>	<b>12%</b>	<b>15%</b>
<b>Oscillatory pump engine power</b>	<b>26%</b>	<b>26%</b>	<b>15%</b>	<b>8%</b>	<b>26%</b>
	Measured flow	Measured flow	Measured flow	Measured flow	Measured flow
<b>Net flow pump engine power</b>	[ml/min]	[ml/min]	[ml/min]	[ml/min]	[ml/min]
<b>100%</b>	159	158	154	156	153
<b>75%</b>	121	124	123	123	120
<b>50%</b>	89	88	88	88	86

On the other hand, to measure the residence time, the ink was added in one end of the reactor and the time was taken from then until the ink poured out from the other end of the system. Results of measured and calculated residence time can be seen in table 10.

Table 10. Calculated and measured residence time with ink experiments.

Cellulose Solid Loading	Experiment number	Net flow pump (NP) and Oscillatory pump (OSZ)	% engine power	Calculated residence time [min]	Measured residence time [min]
<b>5%</b>	VC_I1	NP	100	6,29	2
		OSZ	26		
<b>12%</b>	VC_I2.1	NP	100	6,33	3
		OSZ	26		
	VC_I2.2	NP	100	6,33	2
		OSZ	26		
	VC_I2.3	NP	100	6,29	2
		OSZ	26		
	VC_I3	NP	100	6,49	-
		OSZ	15		
VC_I4	NP	100	6,41	-	
	OSZ	8			
<b>15%</b>	VC_I5	NP	100	6,37	3
		OSZ	26		

The difference between calculated and measured residence time is major, this could be due to the mixing properties of the reactor in continuous mode, which change in respect to batch mode. In batch mode the mentioned plug flow by [35] could be easily identified, with most of the added ink moving up and down with the oscillation and slowly through the reactor in a dark purple block. In the continuous mode this was not the case. The added ink mixed more rapidly with the cellulose and the colour dissipated, creating a light purple that quickly appeared on the other end of the reactor. The influence of the net flow pump could be responsible for this effect, creating what seems to be a faster mixing. To assess this, further studies would be needed in relation to mixing and particle dispersion through the reactor.

Another outcome of this series of experiments was the finding of a suitable cellulose concentration that secured a proper operation of the system, meaning, the concentration that could be processed without causing major clogging problems. It was found that a 12 g of cellulose per 100 ml of buffer provided a slurry that could be handled by the continuous mode configuration, therefore, in hydrolysis tests, this was the concentration of choice.

#### 4.2.2 Power measurements

Since it was the first time using the continuous configuration, the first measurements were done using only water in experiment VC\_W, to get an idea of the functioning of the system and how the net flow pump and oscillatory pump influenced the energy and power consumption. The results for power measurements related to different net flow pump and oscillatory pump configurations and combinations can be seen in figure 24.

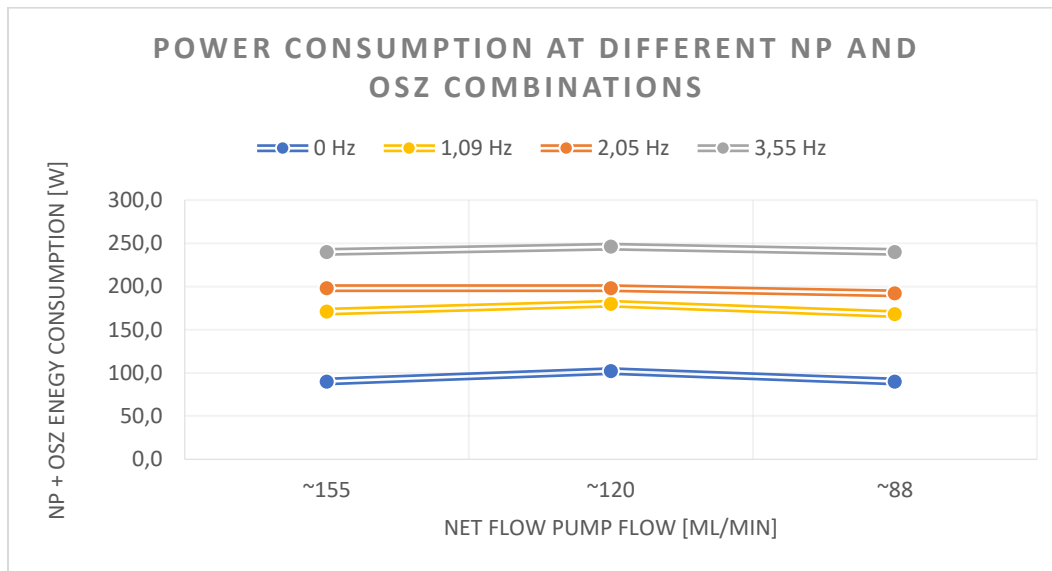

Figure 24. Power consumption at different net flow pump and oscillatory pump configurations for the continuous mode system filled with water.

The main observation from this experiment is how the power consumption increases along with the increment on the frequency but stays almost constant in relation to the net flow configuration at different frequencies. This means the biggest influence on power consumption between the two pumps is the chosen frequency for the oscillatory

pump and not the engine power settings for the new flow pump. In experiments, VC\_I2.1, VC\_I2.2 and VC\_I2.3, the power consumption was measured, this time with the addition of cellulose in 12% solid loading. Since in the water experiment it was found that the oscillatory pump, respectively the frequency settings, had a bigger impact in energy consumption, the power consumption at different frequencies for the previously mentioned experiments is shown in figure 25.

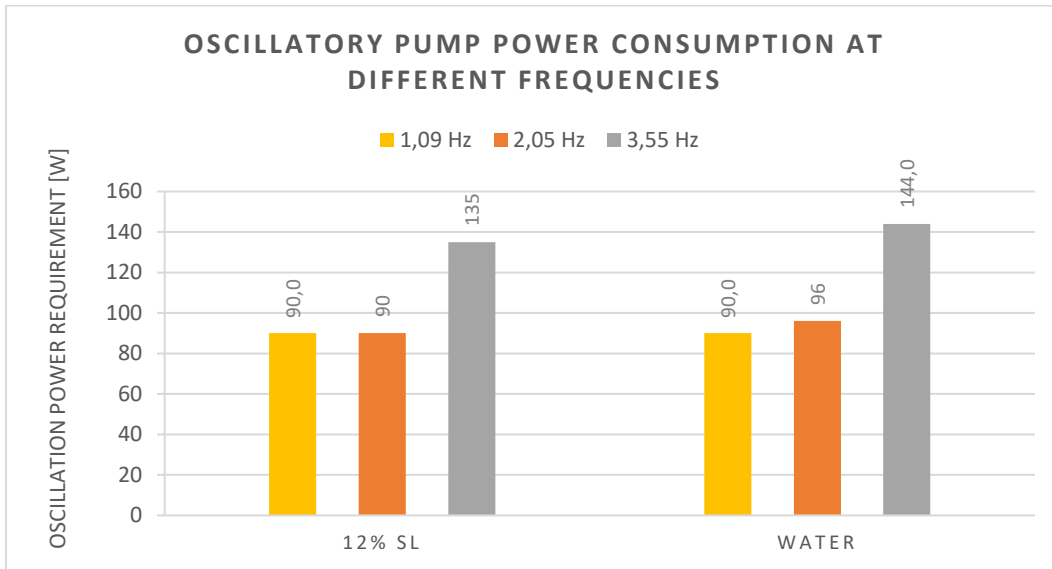

Figure 25. Power consumption of the oscillatory pump with water and 12% solid loading.

Looking at the values for water and the solid loading of 12%, it can be determined that the influence of the particles in the power consumption is not relevant since these measurements were both done for the same amount of time, in this case 16 minutes, and the power consumption is nearly the same. It will not be the exact same amount, since the monitoring system records the consumption every three minutes, and therefore, the power for 16 minutes may vary depending on the times chosen. Other factors to consider regarding the pump might be the lubrication and temperature of the system, which could influence the power consumption.

The main take away from the power measurements is the relation between power consumption and frequency, the bigger the frequency, the bigger the power consumption, as well as the fact that the power consumption seems to be independent from solid loading. A 25% increase in net flow pump engine power means an increase of the flow of 35 ml/min. This quantity does not seem to have an impact on the energy consumption of the net flow pump, with the energy consumption remaining almost constant as the engine power varies. The constant energy consumption could explain the fact that the different solid loadings do not change the power consumption of the net flow pump. The oscillatory pump consumption, on the other hand, varies the energy consumption depending on the frequency that is set up, higher frequencies requiring more effort from the engine, and therefore, a greater energy consumption. The latter means that the solid loading would not affect the energy consumption, as it is only defined by the engine power set to achieve the wanted frequency.

### 4.2.3 Total solids

The total solids were measured in order to get an idea of the mixing and particle distribution along the reactor while the enzymatic hydrolysis was taking place. For the continuous mode, this was tested at a concentration of 12 g of cellulose per 100 ml of buffer and samples were taken at three ports; bottom of the reactor, middle of the reactor and the inlet pipe, the latter being the open space corresponding to modular part D connecting to the net flow pump. The results are shown in figure 26. New elements are added for the continuous mode, a longer system with a greater volume is the result of it. In contrast with the OFB batch layout the volume is double and the incorporation of a net flow pump adding a continuous flow changes the operational parameters.

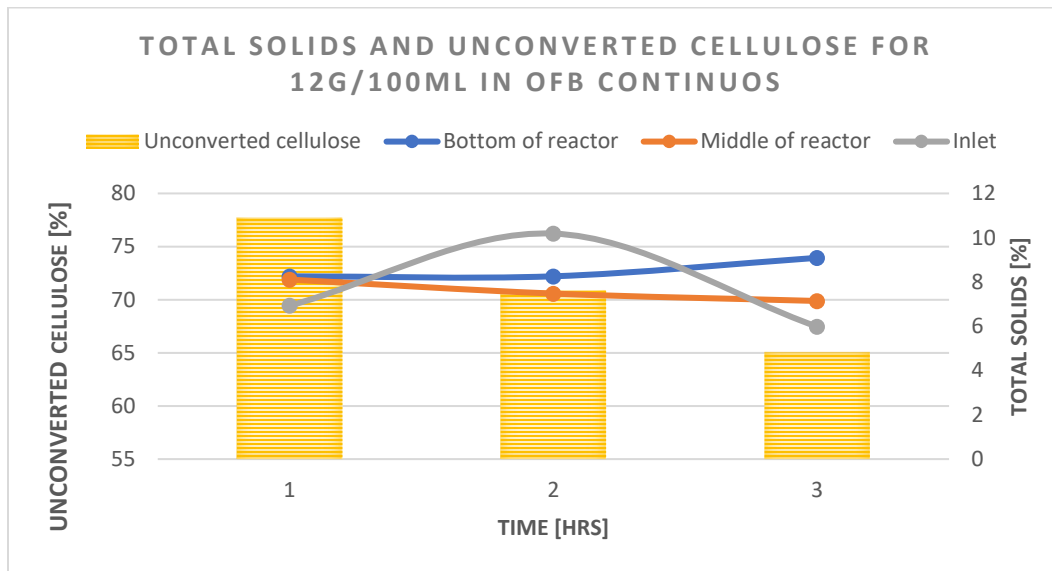

Figure 26. Total solids distribution in 3 ports of the OFB continuous mode configuration, at a 11% solid loading.

Even with the incorporation of the continuous flow, it is seen how with time the total solids decrease in the middle of the reactor while they increase in the bottom of the reactor. As mentioned before in the batch total solids measurements, this could happen due to the influence of the vertical position of the reactor as well as the mixing characteristics of the system, but further particle distribution studies are needed to assess this behaviour more precisely. The solid loadings in percentage for the different ports in the system at three times are shown in table 11.

Table 11. Solid loadings at different ports and times in the hydrolysis of 11% cellulose in continuous mode.

Solid Loading				
Bottom of reactor	Middle of reactor	Inlet	Average SL in System	Expected SL
[%]	[%]	[%]	[%]	[%]
8,26	8,11	6,93	7,77	7,70
8,26	7,48	10,19	8,64	7,03
9,09	7,14	5,98	7,41	6,45

The measurements on the inlet pipe show an accumulation of particles at a given time, this could be seen at times in modular part D, where the mixture of buffer and cellulose coming from the reactor separated briefly at times, with the cellulose sticking to the walls of part D and the liquid going through the pipe. As the flow kept going in, it pushed the cellulose through the pipe again, this is not an ideal condition for the mixing and the enzymatic hydrolysis. It would be expected for the solids to diminish in percentage over time, since the cellulose is converting to glucose and therefore, the available solids decrease. This can be seen in the middle of the reactor in table 11 and figure 26, where the available solids go down as the reaction occurs.

Additionally, the values measured seem to be low in comparison to the expected distribution for an ideal mixing, which would be 10,9%. The values ranged from 5,98% to 10,19% and had an average of 7,64%. This could be explained by the accumulation of particles in certain places of the system. The areas where the clogging usually occurred, were in front of the net flow pump, inside the net flow pump near the outlet, along the inlet pipe and in the modular part G.

#### 4.2.4 Hydrolysis

Hydrolysis in continuous configuration was always conducted with a solid loading of 10,9%, using Cellic CTec2 enzyme with a measured FPU of 144. The cellulose batch used for this set of experiments was the Original batch. Conti 24 has four experiments that lasted for 24 hours, measuring the glucose yield and monitoring the temperature. The following graphs (figure 27) show the results of this series.

In these results it is visible how the temperature affects the enzymatic reaction and therefore the glucose yield obtained. The optimal temperature for the enzyme blend Cellic CTec2 is said to be between 45-50 °C [53]. In experiments 1 and 2, the temperature inside the reactor has an average that is lower than 50 °C through the entire reaction time, 45,6 °C and 48,1°C respectively, as a result, the glucose equivalent yields are  $86,6 \pm 1,08$  mg/ml and  $83,9 \pm 1,08$  mg/ml for said experiments. The enzyme addition was done with the IA method, but with half of the quantity poured into the reactor's top aperture (modular part G) and the other half poured in the longer pipe (modular part D).

On the other hand, in experiments 3 and 4, the temperature inside the reactor is maintained at an average of 51,1 °C and 50,9 °C throughout the experiment. These temperatures that are higher than 50°C, the maximum recommended temperature by the enzyme blend, can be a consequence of the system having variations of temperature along it, with heat losses in pipes that are not fully insulated. Only the modular part M has a double tubular shape with heated water running between the two tubes, therefore having a better heat exchange than the rest of the system. An attempt to improve the heat losses was done by installing a heated tube system that surrounded the pipes and all modular parts, which was then covered by an insulation foam. Nevertheless, the system was not perfectly insulated, and heat losses still took place, which explains the need of a higher temperature in the reactor to maintain an overall temperature that is close to 50°C.



For experiments 3 and 4, there is a noticeable improvement in the glucose yield measured. For experiment 3 the glucose equivalent concentration achieved was  $111,6 \pm 1,08$  mg/ml and for experiment 4  $113,3 \pm 1,08$  mg/ml. These results show that it is crucial to maintain the temperature close to  $51^{\circ}\text{C}$  inside the reactor, since the results in experiment 4 shows an increase of 25% in relation to experiments 1 and 2 in the glucose obtained as a result of the enzymatic hydrolysis. Additionally, in experiments 3 and 4 an improved enzyme addition method was used (IA all in part G). This might have had positive effects on the hydrolysis procedure influencing the results as well. In order to better assess the impact of the enzyme distribution along the reactor in the beginning of the reaction and its impact on the glucose equivalent concentrations obtained, further experiments should be conducted.

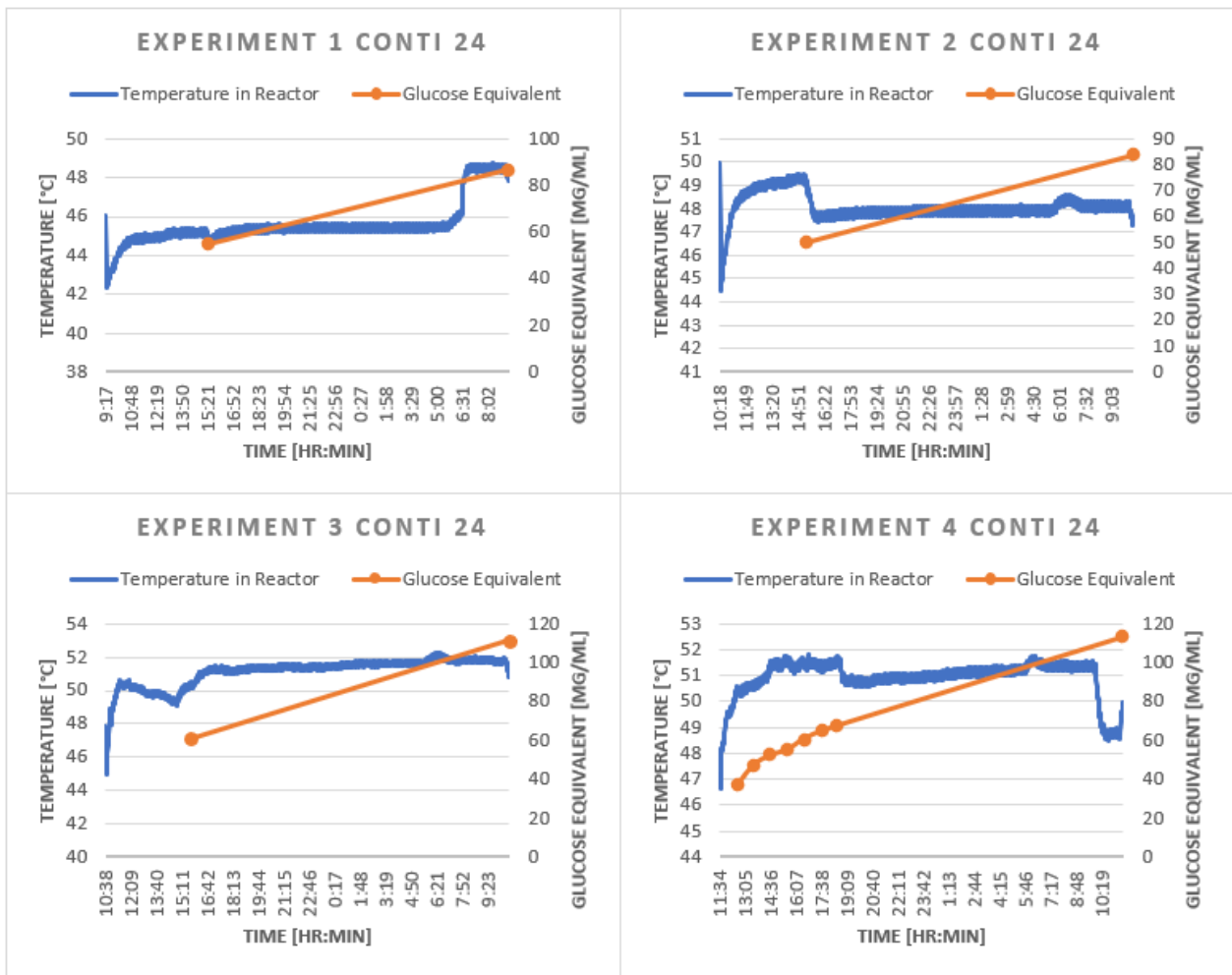

Figure 27. Graphs from the experiment series Conti 24 showing the temperature inside the reactor and the glucose yield along the time.

#### 4.2.4.1 Comparison of hydrolysis results in the different types of processes.

A comparison between the three processes used along the study is crucial to gain a better perspective of the use of the OFB. First, it is important to note that for the OFB-Conti experiment, which corresponds to Conti 12T, the solid loading matches that of the STR, both with 12%. The difference lies in the cellulose type, the STR experiment was

done with Original cellulose while the OFB-conti (Conti 12T) was done with a blend of Original cellulose and Partner cellulose, due to lack of sufficient Original cellulose. In the blend, 83% corresponded to Original cellulose and the remaining 17% to Partner cellulose. The batch experiment shown in 13 was also run with the Original cellulose batch, but with 11% solid loading. All experiments used the same enzyme series with an activity of 144 FPU. The degree of cellulose hydrolysis achieved for the three processes can be observed in figure 28.

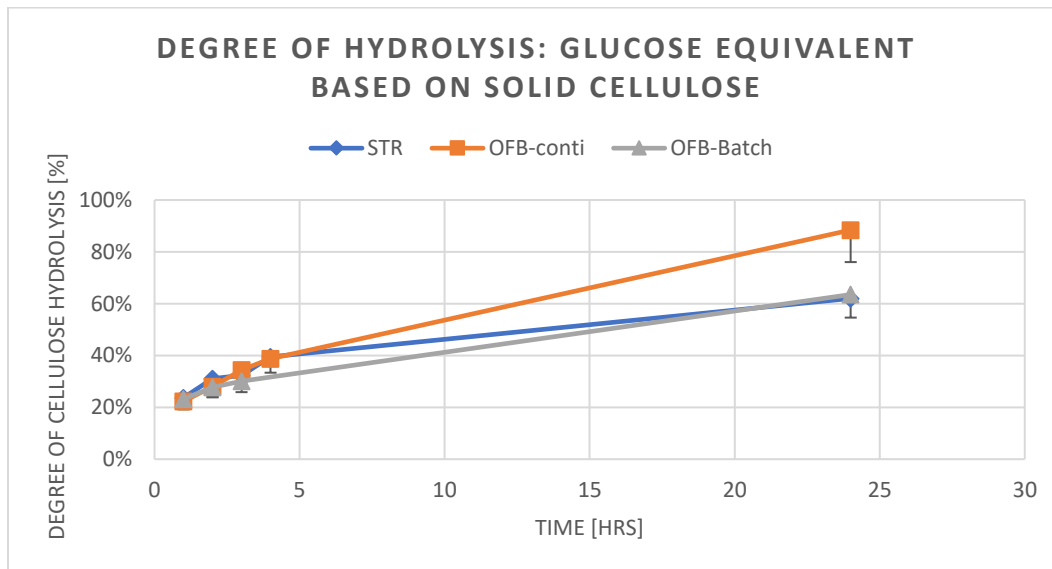

Figure 28. Degree of hydrolysis for the cellulose in OFB-Batch, OFB- Continuous mode and STR.

It is evident that the OFB-Conti results are superior when compared to both STR and OFB-Batch, achieving a degree of cellulose hydrolysis of 88%, being 26% greater than that achieved by the STR, which means that even when considering the 14% error, the OFB-Conti still yields a higher amount of glucose. The improvement in degree of conversion considering the maximum error is 14% higher for OFB-Conti versus the STR process. Even when considering the presence of cellobiose in the solution and considering it for the DMA based calculations, taking the s value associated to 50% cellobiose and 50% glucose, the improvement in the glucose yield is of 10,9%.

The increase happens after the 4 first hours, as seen in the graph, for the first hours the degree of conversion is very close for both methods. For this reason, it would be interesting to conduct further studies on mixing behaviour and enzyme-substrate binding, in order to understand the fundamental reason for which the OFB-Conti process improves with time in such a dramatic way. It is apparent that the OFB's better mixing coupled with a constant flow provided by the net flow pump, increases the enzyme-substrate binding, therefore improving the reaction between enzyme and cellulose and in this way, achieving a greater conversion. This becomes evident when comparing the OFB-Batch results against the OFB-Conti results, the same reactor is used, with the parameters set at equivalent quantities, but with the crucial difference of a constant flow, which makes a remarkable difference for the OFB-Conti results obtaining 24% more conversion.

## 5. Process application

As seen in the previous results, the OFB-Conti shows a great improvement in the process when compared to the results achieved by the STR and OFB batch. The difference in mixing capacities between the OFB-Conti and the STR seem to be the greatest influence on the results. The novelty of the oscillatory movement in combination with the continuous flow provided by the net flow pump, result in a swirl flow that enables the net flow to have slower velocities along the reactor, while the particles move in swirls bumping continuously against the baffles, remaining for a longer time inside the reactor. This improves the processes that require a long residence time, such as the enzymatic hydrolysis of cellulose.

Additionally, the Oscillatory Flow Bioreactor and the mixing properties previously mentioned, have the ability to mix slurries that are dense and more difficult to mix evenly in a STR while distributing the heat among the reactor in an even way. On the other hand, the OFB proved to be more difficult to handle.

Enzymatic hydrolysis of cellulose is not the only process that can be improved by the OFB-Conti system. The production of a variety of chemical and bio-based products have the potential of being enhanced with the use of the OFB-Conti process. In theory, all processes that have a slow reaction time and which need the processing of thick slurries could be improved by the use of this new reactor. Ozone water mass transfer, biofuel production and anaerobic digestion of food-waste are among the processes that can use the OFB in continuous mode to have better results [54–56].

The results of the OFB continuous mode for the conversion of cellulose into glucose, is 10,9-26% higher when compared to the STR results with the same process conditions. Furthermore, if we look at the process considering the time of the reaction, it takes the OFB in continuous mode half of the time to achieve the same concentration as the STR, taking the OFB 12 hours to reach the concentration of 81 mg/ml that takes the STR 24 hours to accomplish.

In order to better visualize and understand the possible impacts of the implementation of the OFB in industry, a comparison is presented between STR and the potential of OFB for the same process; enzymatic hydrolysis of the cellulose in sugar cane bagasse, based on the study by [57]. The feedstock processed is 1000 kg/h (36,9% cellulose) with a conversion efficiency of 98% for cellulose. When changing from 10% biomass concentration in the STR to 35% in the OFB (to be tested based on different substrate conditions, 20% possible based on available data, ambition to reach up to 35%), the sugar concentration increases by a factor 3.5 to 127 g/l. This significant increase in the glucose yield eliminates the evaporation phase that is needed to achieve an estimated concentration target of 85 g/l. This would reduce the energy requirements in downstream processing from 1.2 MW to 0 MW, saving 1,208 t of CO<sub>2</sub> emissions /year. The following table compares the process in STR and OFB in continuous mode, showing the process intensification (PI) parameters (table 12).

Table 12. Comparison of STR vs OFB continuous system.

		STR	OFB	PI factor	
<b>Processing capacity of feedstock</b>	[kg/h]	1000	1000		
<b>Solid loadings</b>	%	10%	35%	3,50	Higher solid concentration
<b>Process Volume [assumption density ~ 1000 kg/m<sup>3</sup>]</b>	[l/h]	10.000	2.857	3,50	Lower process volume
<b>kg glucose per process volume</b>	[g sugar/ l process volume]	36	127	3,50	Increase in product concentration
<b>Vessel size</b>	[m <sup>3</sup> ]	240	34	7,00	Equipment size reduction
<b>Residence time</b>	[h]	24	12	2,00	Residence time reduction
<b>Energy to reach 85 g/l concentration target [assumption: 3 stage evaporation]</b>	[kWh/h]	1197	0		No need of further processing.
<b>GHG emissions / year [natural gas; 5000 h/a]</b>	[t/a]	1208	0		No emissions associated to downstream processing.

Nevertheless, despite the improvements on vessel size, energy and glucose yield, other challenges remain. The need to separate hemicellulose and lignin from the biomass and find ways to make use of this products is a main step to develop in order to make the processing of biomass for the production of bio-based chemicals and fuels competitive in the market. Additionally, the potential to increase the solid loading to 35% needs to be proven.

In any case, this study shows the potential of OFB reactors in biomass processing when compared to STR, by showing a 10,9-26% higher degree of conversion in hydrolysis for pure  $\alpha$ -cellulose. The capacity of the OFB to process higher solid loadings is of great importance and represents a significant improvement compared to STR systems. Furthermore, a high degree of mixing is achieved using a lower energy intensive process, and as an outcome, higher solid loadings can be processed. The lower amount of energy consumption, at the same time, translates into lower greenhouse gases emissions.

## 6. Challenges and future work

The oscillatory flow bioreactor laboratory plant has proven to work without any problems in batch mode, as also found by [5]. This time, the laboratory plant was also tested in continuous mode, finding a layout that was assembled and tried out with different solid loadings. The tests performed were conducted with the aim of comparing the results with other processing methods that are commonly used in the industry, in this case, stirred tank reactors (STR). Measurements in glucose yield, energy and total solids were carried out, to compare the performance of the three different processes: stirred tank reactor, OFB in batch mode and OFB in continuous mode.

Stirred tank tests were performed by partner ACIB, while both OFB layout tests were performed at AEE INTEC, using the OFB pilot plant. The batch mode layout was similar to that previously used by [5], but in terms of materials, differences between used enzyme batches and cellulose batches were found. In this occasion, the enzyme batch used had a measured FPU of 144 and in the previous study, the enzyme blend showed an enzyme activity of 140 FPU. This had an impact in the results, yielding higher glucose concentrations. For this reason, tests in batch mode were performed again, in order to have comparable results for the intended experiments in continuous mode and to compare with STR results as well.

Another difference was that while the previous study showed comparable results between DMA and DNS measurements, this study showed a significant variation between the results, with the DMA density measurement-based glucose calculation resulting in a glucose concentration that reached a 14% of error, giving higher concentrations than the DNS. This error was taken into account for all hydrolysis results that compare the STR hydrolysis of cellulose with the OFB. In addition to this, it was found that the presence of cellobiose should be considered for the DMA measurements, as it has a higher density than glucose and when using the calibration of the buffer with glucose, the cellobiose presence is not considered. Therefore, for future work, the ratio of cellobiose and glucose should be identified in order to properly calculate a calibration line for the buffer. Additionally, HPLC tests should be conducted to precisely identify the presence of the different sugars in the filtrate.

In batch mode, two methods of enzyme addition were analysed, inline addition (IA) and pre-addition (PA), with the first one showing improved results. The IA yielded glucose concentrations that were 7,13% higher compared to the pre-addition method. Given this result, it was decided that for experiments in continuous mode the enzyme would always be added directly into the reactor, following the inline addition procedure (IA). As for the 24-hour experiments in batch, the highest glucose yield achieved was  $82,9 \pm 1,08$  mg/ml.

Comparing the performance of the OFB batch experiments with STR experiments that went on for 24 hours, showed that the glucose yields are similar in both cases. The main difference seemed to take place during the first hours of experiment (3-6 hours). The STR presents a rapid increase in the first hours and as the reaction advances, the yields reach nearly the same concentration at 24 hours for both processes. For future work, it would be interesting to have

more measurements done along the 24-hour reaction, the first 6 hours in both processes and then the last 4 hours, to take a closer look at the glucose yield in time.

The use of another lignocellulosic material was attempted. Arbocel, a plant-based material which has a bigger particle size than pure  $\alpha$ -cellulose, composed by 99,5% cellulose, with the rest being lignin and hemicellulose, was tested in batch mode. The experiment was run for 24 hours, with the same amount of enzyme as that used for the cellulose experiments. The results in contrast with the STR process, show that the increase in the glucose yield for the first hours is smaller, but by the end of the reaction, the yields, once again, are nearly the same. This time batch results are slightly greater, achieving 1,1 mg/ml more than the STR mode. Although, when the maximum error of 14% was considered, the STR would perform better than OFB in batch mode.

Additionally, total solids were measured while the enzymatic hydrolysis of  $\alpha$ -cellulose was taking place inside the reactor. The results show that the mixing is not even along the length of the reactor, which could in part be a consequence of the position of the reactor, vertical, and therefore, by gravity heavier particles would tend to accumulate in the bottom of the reactor. The 90° bend between the oscillatory pump and the reactor could have influenced the particle accumulation in this area and represent a challenge for the mixing capacities of the oscillatory pump. The middle of the reactor, on the other hand, shows results which are in accordance with what is expected. A linear decrease on the solid loadings with time, as the solid cellulose particles transform into liquid glucose. Longer solid loading tests would better display the mixing along the reactor and the relation with the unconverted cellulose.

For the continuous mode experiments, the chosen layout, as described in section 3.1.1.2, showed good results for solid loading up to 12%, with the potential of treating higher solid loadings. This was concluded after running the parametric tests. A difference that came to light during these set of experiments, was the flow behaviour observed in the ink experiments. Unlike batch ink experiments, continuous mode did not present the plug flow behaviour described by [35]. The ink was mixing at a rapid time, spreading all along the reactor, showing a light purple colour when mixed with the cellulose. This made the calculated residence time seem much greater than the measured residence time, since the ink was quickly transported along the system, taking just 2 to 3 minutes to appear on the other end of the continuous OFB system, which corresponded to half of the calculated residence time. This could be a result of the incorporation of the net flow pump. The continuous flow that run through the system, which seemed to have an immediate effect on the mixing characteristics of the slurry contained in the system, no longer presenting the plug flow behaviour. Further studies would be needed to identify the reasons behind the mixing differences between batch mode and continuous mode. These results could be crucial to understand what type of mixing enhances the enzymatic hydrolysis.

With the power measurements, it became clear that the mayor influence on the power consumption in the system is dictated by the frequency that is programmed for the oscillatory pump. This seemed to be consistent even when treating different solid loadings, the consumption was always linked to the set frequency, with the net flow pump having apparently no great influence on power consumption. The consumption of the net flow pump seemed to be

linked only to the dimensions of it, with a rather fixed energy consumption. The bigger the frequency, the larger the amount of power consumed by the system.

The total solids measured for the continuous mode, showed an uneven distribution of solids. The system's layout is much more complex than that of the batch mode, presenting a series of curves and bends along the configuration. This presents challenges for the continuous flow of the cellulose-buffer slurry. The most difficult area was the part in front of the net flow pump. Several experiments failed due to the clogging which occurred along it. Improvements were made with the installation of heating of pipes with heated water that surrounded this part, in order to reduce the chances of clogging. Additionally, the system was shortened, and a determined filling procedure was found to be helpful. Despite all attempts, the system was not perfect, which was made evident by the results of the total solids. Once again, as seen in the batch mode, the middle of the reactor presented the expected behaviour, with the total solids decreasing with the time. Mixing in the reactor has to be assessed and a solution might be found to secure an even and homogeneous mixing throughout the reactor. A better layout of the system with less bends and curves could help the mixing outcome, as well as a continuous connection, with just one open space between modular parts.

For the hydrolysis results, in the 24 hours experiment set Conti 24, the influence of the temperature is easily observed. It appears that a temperature close to 51 °C inside the modular part M has a positive impact in the hydrolysis results, even with the recommended temperature of the enzyme blend being in the range of 45-50°C. This higher temperature needed can be due to the losses along the system, in modular parts that are not perfectly insulated and possess a lower heat exchange with the heating pipes than that inside the double tubular modular part M. This increase in temperature might have secured an overall optimal temperature of 50°C along the system, but studies on the heat transfer along the system would be needed to prove this hypothesis.

Lower temperatures significantly decrease the glucose equivalent yield by nearly 25%. It is crucial then, to maintain a constant temperature along the system with 50-51°C. The enzyme method of addition in all the set was the inline addition, but the enzyme was distributed differently by adding the enzyme in two different locations for the experiments that yielded a lower glucose (and coincide with the lower temperature) while the highest yields were achieved with all the enzyme added directly into the reactor (higher temperature experiments). To properly interpret if there was an influence of the enzyme distribution in the glucose yield, more experiments would need to be executed.

Overall, the OFB continuous mode process showed a superior performance when compared to OFB batch configuration experiments and STR. The OFB continuous mode is superior and yielded a degree of cellulose hydrolysis of 88%, as opposed to the STR method which only achieved 62% degree of conversion in the same amount of time, 24 hours. These results show that even when considering the error of 14%, the performance of the OFB in continuous mode is far superior, having 14% more of conversion. Furthermore, with the estimation of a 50% glucose and 50% cellobiose in the filtrate, a new  $s$  was calculated and with it a more realistic glucose yield. As a result, the OFB

continuous mode showed a 10,9% increase in glucose yield when considering the cellobiose calibration compared to the STR.

Longer experiments with more measurements could better describe the differences between STR and OFB in continuous mode results. This coupled with mixing tests, particle distribution and enzyme-substrate binding would better explain what makes the OFB-Conti have a better conversion.

It could be that the better and rapid mixing in the OFB with continuous flow enhances the interaction between enzyme and substrate, giving more chances for the particles to collide and react in a shorter period of time. This could explain the better overall performance of the OFB. On the other hand, it was observed that the STR tank presented more rapid increase in the glucose yield for the first hours as opposed to the OFB. This would mean that the reaction benefits from a slower, less effective mixing at the beginning of the reaction. Further research should be performed to better understand this phenomenon.

Among the challenges in the work, besides the improvement of the continuous mode layout, it seems important to keep a constant diameter along the system. The net flow pump had a smaller tubing system inside and was often clogged in the first experiments in continuous mode. A larger pump with a diameter that coincides with the rest of the system would decrease the possibility of clogging in the pump.

Additionally, a small change in the particle sizes of the cellulose had a big effect on the system. The cellulose batch named NEW could not be used, since all the attempts of experiments in continuous mode with it failed. Clogging occurred in different parts of the system; long inlet pipe, modular part G and net flow pump, making it impossible to work with it. This has to be considered for future work. As mentioned before, it could present an improvement with a better design and layout of the system, with a continuous diameter, all parts baffled and soft bends. The position of the system might have an influence as well. A continuous mode layout in horizontal position could be tested in order to assess the influence of the vertical position in the particle distribution along the reactor.

Besides the need for ongoing research, the OFB technology is promising for reactions that require a long residence time. Its capacity to work at higher loadings decreases the volume of the vessel considerably, since the volume to be processed to yield a certain amount of product decreases. The improved mixing in the reactor enhances the reactions and reduces the time needed to achieve the wanted concentration. Additionally, since higher concentrations can be achieved due to the improvement on the degree of conversion, the energy costs associated with downstream processing would be decreased. All of this translates into savings and would be a great step towards more economic and environmentally friendly solutions for different types of industry that currently rely on STR for slow reactions which require a long residence time.



## REFERENCES

1. Isikgor FH, Becer CR. Lignocellulosic biomass: a sustainable platform for the production of bio-based chemicals and polymers. *Polym Chem*. 2015;6:4497–559.
2. Brethauer S, Wyman CE. Review: Continuous hydrolysis and fermentation for cellulosic ethanol production. *Bioresour Technol* [Internet]. Elsevier Ltd; 2010;101:4862–74. Available from: <http://dx.doi.org/10.1016/j.biortech.2009.11.009>
3. A. Shatalov A, Pereira H. Biorefinery of Energy Crop Cardoon(*Cynara cardunculus* L.)-Hydrolytic Xylose Production as Entry Point to Complex Fractionation Scheme. *J Chem Eng Process Technol*. 2012;02.
4. Wyman CE, Dale BE, Balan V, Holtzapple MT. Aqueous Pretreatment of Plant Biomass for Biological and Chemical Conversion to Fuels and Chemicals 34 SBE Update : Biofuels Meet the Authors The Need for Biofuels Producing Biofuels via the Thermochemical Platform Producing Biofuels via the Sugar Platfor. 2013;
5. Griesbacher MU. Enzymatic Saccharification of Cellulose in an Oscillatory Flow Bioreactor . 2019;
6. Morgan HM, Bu Q, Liang J, Liu Y, Mao H, Shi A, et al. A review of catalytic microwave pyrolysis of lignocellulosic biomass for value-added fuel and chemicals. *Bioresour Technol* [Internet]. Elsevier Ltd; 2017;230:112–21. Available from: <http://dx.doi.org/10.1016/j.biortech.2017.01.059>
7. Agbor VB, Cicek N, Sparling R, Berlin A, Levin DB. Biomass pretreatment: Fundamentals toward application. *Biotechnol Adv* [Internet]. Elsevier Inc.; 2011;29:675–85. Available from: <http://dx.doi.org/10.1016/j.biotechadv.2011.05.005>
8. Zhang B, Von Keitz M, Valentas K. Thermal effects on hydrothermal biomass liquefaction. *Appl Biochem Biotechnol*. 2008;147:143–50.
9. Jørgensen H, Kristensen JB, Felby C. Enzymatic conversion of lignocellulose into fermentable sugars: Challenges and opportunities. *Biofuels, Bioprod Biorefining*. 2007;1:119–34.
10. Taherzadeh MJ, Karimi K. Pretreatment of Lignocellulosic Wastes to Improve Ethanol and Biogas Production : A Review. 2008.
11. Warren E. Mabee, David J. Gregg, Claudio Arato Alex Berlin, Renata Bura, Neil Gilkes Olga Mirochnik, Xuejun Pan, E. Kendall Pye Saddler1 *AJN*. Updates on Softwood-to-Ethanol Process. 2006;129.
12. James D. Stephen, Warren E. Mabee JNS. Will second-generation ethanol be able to compete with first-generation ethanol? Opportunities for cost reduction. *Biofuels, Bioprod Biorefining*. 2012;6:159–76.
13. Lynd LR, Laser MS, Bransby D, Dale BE, Davison B, Hamilton R, et al. How biotech can transform biofuels. 2008;

14. Phitsuwan P, Sakka K, Ratanakhanokchai K. Improvement of lignocellulosic biomass in planta : A review of feedstocks , biomass recalcitrance , and strategic manipulation of ideal plants designed for ethanol production and processability. 2013;405:390–405.
15. Abdel-Rahman MA, Tashiro Y, Sonomoto K. Lactic acid production from lignocellulose-derived sugars using lactic acid bacteria: Overview and limits. *J Biotechnol* [Internet]. Elsevier B.V.; 2011;156:286–301. Available from: <http://dx.doi.org/10.1016/j.jbiotec.2011.06.017>
16. Chen J, Zhang W, Tan L, Wang Y, He G. Optimization of metabolic pathways for bioconversion of lignocellulose to ethanol through genetic engineering. *Biotechnol Adv* [Internet]. Elsevier Inc.; 2009;27:593–8. Available from: <http://dx.doi.org/10.1016/j.biotechadv.2009.04.021>
17. Holwerda EK, Worthen RS, Kothari N, Lasky RC, Davison BH, Fu C, et al. Biotechnology for Biofuels Multiple levers for overcoming the recalcitrance of lignocellulosic biomass. *Biotechnol Biofuels* [Internet]. BioMed Central; 2019;1–12. Available from: <https://doi.org/10.1186/s13068-019-1353-7>
18. Carpita NC, Defernez M, Findlay K, Wells B, Shoue DA, Catchpole G, et al. Cell wall architecture of the elongating maize coleoptile. *Plant Physiol*. 2001;127:551–65.
19. Rosa Estela Quiroz-Castañeda JLF-M. Hydrolysis of Biomass Mediated by Cellulases for the Production of Sugars. *Sustain Degrad Lignocellul Biomass - Tech Appl Commer Dr Anuj Chandel* [Internet]. 2013;13. Available from: <https://www.intechopen.com/books/advanced-biometric-technologies/liveness-detection-in-biometrics>
20. Nishiyama Y, Sugiyama J, Chanzy H, Langan P. Crystal Structure and Hydrogen Bonding System in Cellulose I $\alpha$  from Synchrotron X-ray and Neutron Fiber Diffraction. *J Am Chem Soc*. 2003;125:14300–6.
21. Laureano-Perez L, Teymouri F, Alizadeh H, Dale BE. Understanding factors that limit enzymatic hydrolysis of biomass: Characterization of pretreated corn stover. *Appl Biochem Biotechnol - Part A Enzym Eng Biotechnol*. 2005;124:1081–99.
22. Fan Z. Consolidated Bioprocessing for Ethanol Production [Internet]. *Biorefineries Integr. Biochem. Process. Liq. Biofuels*. Elsevier B.V.; 2014. Available from: <http://dx.doi.org/10.1016/B978-0-444-59498-3.00007-5>
23. Merino ST, Cherry J. Progress and challenges in enzyme development for biomass utilization. *Adv Biochem Eng Biotechnol*. 2007;108:95–120.
24. Amiri H, Karimi K. Pretreatment and hydrolysis of lignocellulosic wastes for butanol production: Challenges and perspectives [Internet]. *Bioresour. Technol*. Elsevier Ltd; 2018. Available from: <https://doi.org/10.1016/j.biortech.2018.08.117>
25. Bin Yang, Ziyu Dai, Shi-You Ding, Charles E Wyman. Enzymatic hydrolysis of cellulosic biomass. *Biofuels*. 2011;2:421–49.

26. Gan Q, Allen SJ, Taylor G. Design and operation of an integrated membrane reactor for enzymatic cellulose hydrolysis. *Biochem Eng J.* 2002;12:223–9.
27. Wang W, Kang L, Wei H, Arora R, Lee YY. Study on the decreased sugar yield in enzymatic hydrolysis of cellulosic substrate at high solid loading. *Appl Biochem Biotechnol.* 2011;164:1139–49.
28. Kristensen JB, Felby C, Jørgensen H. Determining yields in high solids enzymatic hydrolysis of biomass. *Appl Biochem Biotechnol.* 2009;156:127–32.
29. Rosgaard L, Andric P, Dam-Johansen K, Pedersen S, Meyer AS. Effects of substrate loading on enzymatic hydrolysis and viscosity of pretreated barley straw. *Appl Biochem Biotechnol.* 2007;143:27–40.
30. Andrić P, Meyer AS, Jensen PA, Dam-Johansen K. Reactor design for minimizing product inhibition during enzymatic lignocellulose hydrolysis: I. Significance and mechanism of cellobiose and glucose inhibition on cellulolytic enzymes. *Biotechnol Adv.* 2010;28:308–24.
31. Nguyen LT, Neo KRS, Yang KL. Continuous hydrolysis of carboxymethyl cellulose with cellulase aggregates trapped inside membranes. *Enzyme Microb Technol* [Internet]. Elsevier Inc.; 2015;78:34–9. Available from: <http://dx.doi.org/10.1016/j.enzmictec.2015.06.005>
32. Medve J, Karlsson J, Lee D, Tjerneld F. Hydrolysis of microcrystalline cellulose by cellobiohydrolase I and endoglucanase II from *Trichoderma reesei*: Adsorption, sugar production pattern, and synergism of the enzymes. *Biotechnol Bioeng.* 1998;59:621–34.
33. Markus Linder TTT. The roles and function of cellulose-binding domains. *J Biotechnol* [Internet]. 1997;57:1–14. Available from: <papers2://publication/uuid/5DB75BDD-CEB9-41FF-A584-1A7B6821940F>
34. Stephen Wald, Charles R. Wilke and HWB. Kinetics of the enzymatic hydrolysis of sarin. *Can J Biochem Physiol.* 1983;34:80–2.
35. Ni X-W. Continuous Oscillatory Baffled Reactor Technology. *Innov Pharm Technol.* 2006;8–12.
36. Abbott MSR, Valente Perez G, Harvey AP, Theodorou MK. Reduced power consumption compared to a traditional stirred tank reactor (STR) for enzymatic saccharification of alpha-cellulose using oscillatory baffled reactor (OBR) technology. *Chem Eng Res Des* [Internet]. Institution of Chemical Engineers; 2014;92:1969–75. Available from: <http://dx.doi.org/10.1016/j.cherd.2014.01.020>
37. Phan AN, Harvey AP. Characterisation of mesoscale oscillatory helical baffled reactor-Experimental approach. *Chem Eng J* [Internet]. Elsevier B.V.; 2012;180:229–36. Available from: <http://dx.doi.org/10.1016/j.cej.2011.11.018>
38. Stonestreet P, Van Der Veeken PMJ. The effects of oscillatory flow and bulk flow components on residence time distribution in baffled tube reactors. *Chem Eng Res Des.* 1999;77:671–84.

39. Levenspiel O. Chemical Reaction Engineering. *Ind Eng Chem Res.* 1999;4140–3.
40. McDonough JR, Phan AN, Harvey AP. Rapid process development using oscillatory baffled mesoreactors - A state-of-the-art review. *Chem Eng J [Internet]. Elsevier B.V.;* 2015;265:110–21. Available from: <http://dx.doi.org/10.1016/j.cej.2014.10.113>
41. Harvey AP, Mackley MR, Stonestreet P. Operation and optimization of an oscillatory flow continuous reactor. *Ind Eng Chem Res.* 2001;40:5371–7.
42. Solano JP, Herrero R, Espín S, Phan AN, Harvey AP. Numerical study of the flow pattern and heat transfer enhancement in oscillatory baffled reactors with helical coil inserts. *Chem Eng Res Des [Internet]. Institution of Chemical Engineers;* 2012;90:732–42. Available from: <http://dx.doi.org/10.1016/j.cherd.2012.03.017>
43. Brunold R, Hunns JCB. Losses for Oscillatory. *Chem Eng.* 1989;44:1227–44.
44. Stephanoff, K.D., Sobey, I.A., Bellhouse BJ. On flow through furrowed channels . Part 2 . Observed flow patterns. *J Fluid Mech.* 1980;96:27–32.
45. Hewgill MR, Mackley MR, Pandit AB, Pannu SS. Enhancement of gas-liquid mass transfer using oscillatory flow in a baffled tube. *Chem Eng Sci.* 1993;48:799–809.
46. Ferreira A, Teixeira JA, Rocha F. O<sub>2</sub> mass transfer in an oscillatory flow reactor provided with smooth periodic constrictions. Individual characterization of  $k_L$  and  $a$ . *Chem Eng J [Internet]. Elsevier B.V.;* 2015;262:499–508. Available from: <http://dx.doi.org/10.1016/j.cej.2014.09.125>
47. Dickens AW, Mackley MR, Williams HR. Experimental residence time distribution measurements for unsteady flow in baffled tubes. *Chem Eng Sci.* 1989;44:1471–9.
48. Ikwebe J, Harvey A. Kinetics of Cellulose Hydrolysis in an Oscillatory Baffled Reactor. *Am J Biomass Bioenergy.* 2016;
49. Henderson SK, Fenn CA, Domijan JD. Determination of sugar content in commercial beverages by density: A novel experiment for general chemistry courses. *J Chem Educ.* 1998;75:1122–3.
50. Paar A. DMA 35 Portable Density Meter - Instruction Manual. 2010;12.
51. Adney B, Baker J. Measurement of cellulase activities laboratory. Tech Rep NREL/TP-510-42628. 2008;8.
52. Ghose TK. Measurement of Cellulase Activities. *Pure Appl Chemistry.* 1987;59:57—268.
53. Novozymes A/S. Application sheet: Cellic<sup>®</sup> CTec2 and HTec2 - Enzymes for hydrolysis of lignocellulosic materials. 2010;1–9.
54. Masngut N, Harvey AP, Ikwebe J. Potential uses of oscillatory baffled reactors for biofuel production. *Biofuels.*

2010;1:605–19.

55. Al-Abduly A, Christensen P, Harvey A, Zahng K. Characterization and optimization of an oscillatory baffled reactor (OBR) for ozone-water mass transfer. *Chem Eng Process Process Intensif* [Internet]. Elsevier B.V.; 2014;84:82–9. Available from: <http://dx.doi.org/10.1016/j.cep.2014.03.015>

56. Wang S, Peng L, Jiang Y, Gikas P, Zhu B, Su H. Evaluation of A Novel Split-Feeding Anaerobic/Oxic Baffled Reactor (A/OBR) for Foodwaste Anaerobic Digestate: Performance, Modeling and Bacterial Community. *Sci Rep* [Internet]. Nature Publishing Group; 2016;6:1–14. Available from: <http://dx.doi.org/10.1038/srep34640>

57. Rabelo SC, Carrere H, Maciel Filho R, Costa AC. Production of bioethanol, methane and heat from sugarcane bagasse in a biorefinery concept. *Bioresour Technol* [Internet]. Elsevier Ltd; 2011;102:7887–95. Available from: <http://dx.doi.org/10.1016/j.biortech.2011.05.081>